

Analysis of a Building with XC

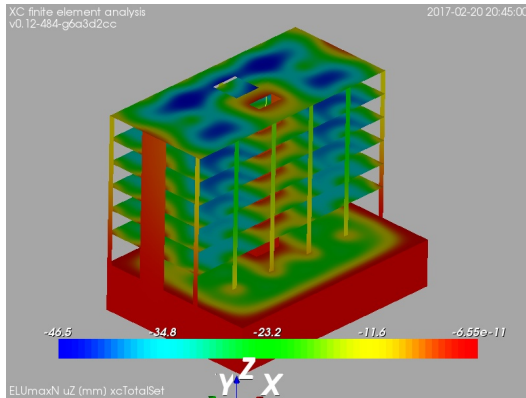

XC in order to obtain the displacements and internal forces in the structure caused by a set of load combinations. In upcoming exercises the verifications relating to limit states will be carried out.



Ana Ortega, Luis C. Pérez Tato

Description of the Building

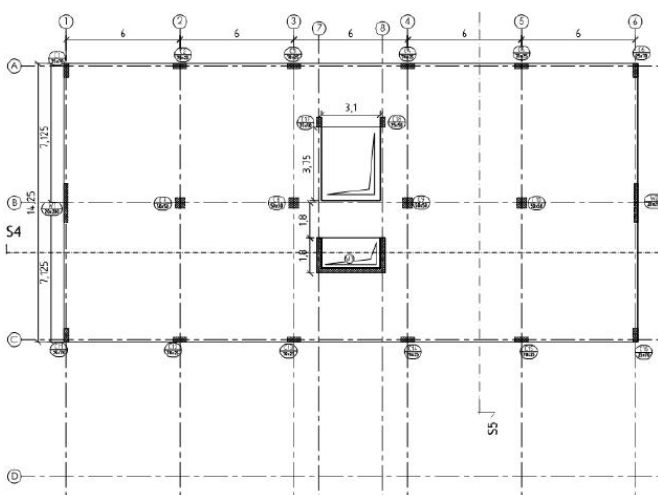

Figure 1: Floor plan dimensions [m]. Reprinted from [1]

The building, ideally located in an urban area, is occu-

ped by offices open to public in the ground floor, storeys first to fifth are for dwellings and the two underground floors are intended to parking. Its main dimensions are depicted in figures 1 to 3. The slabs are of type flat concrete solid spanning in both X and Y directions with depth $h=21$ cm. Shear walls from the staircase area and facade have a width 30 cm, the inner columns are square 0.5×0.5 in cross-section. The outer columns and the shear walls are supported by a peripheral diaphragm retaining wall of width 0.6 m.

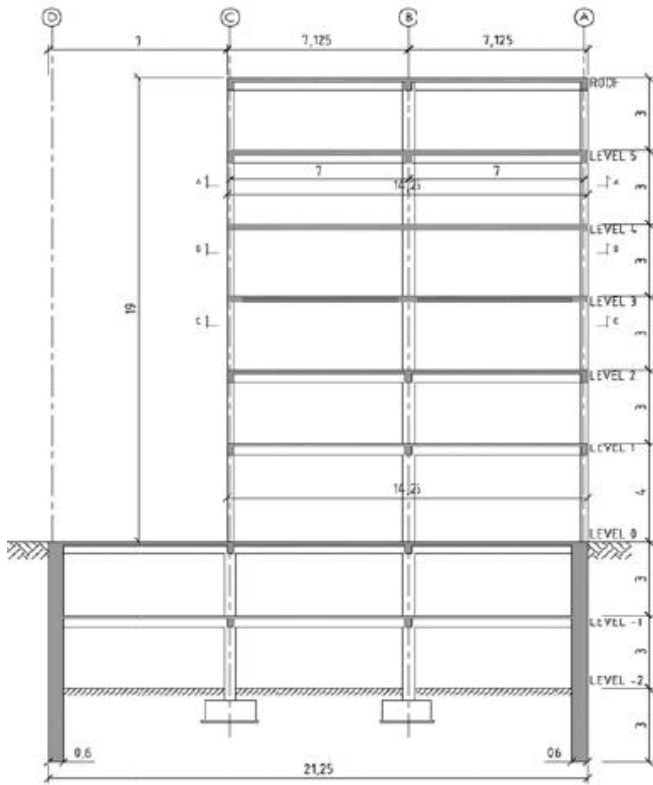

Figure 2: Section 1. Reprinted from [1]

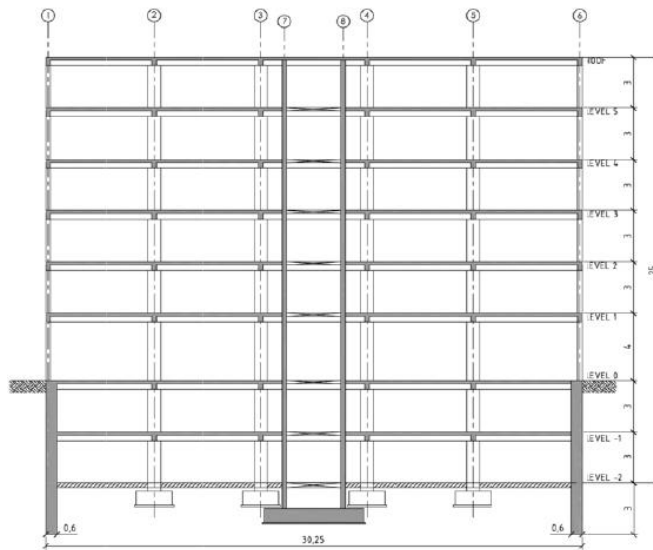

Figure 3: Section 2. Reprinted from [1]

Finite element model

A three-dimensional model of the structure has been built, all the scripts related to this model are hosted here in GitHub.

The geometry is organized by making use of a grid of coordinates, which points will be the vertices of the rectangles, lines and other primitives that will define the shapes. This grid matches the axes graphically represented in figures 1 to 3.

The global coordinate system is oriented so that the X axis is horizontal, in the largest dimension of the building, Y is horizontal perpendicular to X, and Z is a vertical axis in opposite sense to gravitational force.

A concrete material defined by its Young's modulus, mass density and Poisson's ratio is added to the material container. The next step is to define the section-materials appropriates for modeling the different components of the structure. We use an isotropic section-material of type shell with shield and plate work for the analysis of slabs and walls; for the columns a 3D beam elastic section including shear deformation is used.

The model is meshed automatically using a global elements size of 0.5 m. A total of 24084 elements are generated, of which 200 are of type beam and 23884 are shell elements. Zero displacement constraints are applied to all the nodes contained in the plane $Z=0$.

Loads, load cases and combinations

In the table 3 all the load cases considered for the analysis are depicted. The values of the loads, as well as their factors of combination, are reported in the table 1, extracted from reference [1]. Most of them are applied to the FE model as uniform loads on surfaces; figures 5 to 27 show the load distribution in the model for each of these load cases.

Several combinations in ultimate limit states are analyzed, load cases are combined using the partial and combination factors depicted in tables 2 and 1. The full list of limit states analyzed is shown in table 4.

Results of structural analysis

A static analysis using a linear algorithm is performed to achieve the solution for each combination of load cases. Figures 29 to 166 show the displacements and internal forces and moments obtained as a result of the analysis. Displacements are expressed in the global coordinate system. On the other hand, internal forces and bending moments refers to the following local coordinate systems (see figure 4):

position	axis 1[x]	axis 2[y]	axis 3[z]
slab	X	Y	Z
walls XZ plane	Z	X	Y
walls YZ plane	Y	Z	X
columns	Z	Y	X

Class	Load name	Value of load	Ψ_0	Ψ_2
Dead load	dead load of construction	$\gamma_{reinfc.concrete} = 25 \text{ kN/m}^3$		
	dead load of interior	3.0 kN/m^2		-
	dead load of facade	8.0 kN/m		
Environmental load 1	wind (below 1000m above sea level) between 10 m and 19 m linear rising	0.77 kN/m^2 below 10 m 1.09 kN/m^2 at 19 m	0.6	0
Environmental load 2	snow on roof or external area	1.70 kN/m^2	0.5	0
Service load 1	dwelling (level 1-6)	2.00 kN/m^2		
	stairs, office (level 0)	4.00 kN/m^2	0.7	0.3
Service load 2	parking (level -1, -2, external area)	2.50 kN/m^2	0.7	0.6

Table 1: Loads. Table taken from [1]

Class	favourable	unfavourable
Self-weight G_1	-	$\gamma_G=1.35$
Permanent loads G_2	$\gamma_G=1.00$	$\gamma_G=1.35$
Variable loads Q_i	$\gamma_Q=0.00$	$\gamma_G=1.50$

Table 2: Partial factors

Class	Load case Id	Load case description	see figure
Dead loads	LC1	dead load of the bearing structure	5
	LC2	dead load of the interior	6
	LC3	dead load of the facade	7
Environmental loads	LC51	wind in global X direction	8
	LC101	wind in global Y direction	9
	LC201	snow on the roof	10
	LC202	snow on the external area between axes 1 and 2	11
	LC203	snow on the external area between axes 2 and 3	12
	LC204	snow on the external area between axes 3 and 4	13
	LC205	snow on the external area between axes 4 and 5	14
Service loads	LC206	snow on the external area between axes 5 and 6	15
	LC1326	service load 1 on the roof, arrangement 1	16
	LC1336	service load 1 on the roof, arrangement 2	17
	LC1356	service load 1 on the roof, arrangement 3	18
	LC1366	service load 1 on the roof, arrangement 4	19
	LC10001	service load 1 on levels 0 to 5, arrangement 1	20
	LC10011	service load 1 on levels 0 to 5, arrangement 2	21
	LC10021	service load 1 on levels 0 to 5, arrangement 3	22
	LC10031	service load 1 on levels 0 to 5, arrangement 4	23
	LC10101	service load 2 on levels -1 and -2, arrangement 1	24
LC10111	service load 2 on levels -1 and -2, arrangement 2	25	
LC10121	service load 2 on levels -1 and -2, arrangement 3	26	
LC10131	service load 2 on levels -1 and -2, arrangement 4	27	

Table 3: Load cases

Target	Combination Id	Combination expression
max M_y	ELUmaxMy	$1.35 \times LC1 + 1.35 \times LC2 + 1.35 \times LC3 + 1.5 \times LC101 + 0.75 \times LC203 + 0.75 \times LC204 + 0.75 \times LC205 + 0.75 \times LC206 + 1.05 \times LC1356 + 1.05 \times LC10111$
max M_z	ELUmaxMz	$1.35 \times LC1 + 1.35 \times LC2 + 1.35 \times LC3 + 1.5 \times LC10111 + 0.9 \times LC51 + 0.75 \times LC203 + 0.75 \times LC204 + 0.75 \times LC205 + 0.75 \times LC206 + 1.05 \times LC10011$
max V_y	ELUmaxVy	$1.35 \times LC1 + 1.35 \times LC2 + 1.35 \times LC3 + 1.5 \times LC10111 + 0.9 \times LC51 + 0.75 \times LC203 + 0.75 \times LC204 + 0.75 \times LC205 + 0.75 \times LC206 + 1.05 \times LC10011$
max V_z	ELUmaxVz	$1.35 \times LC1 + 1.35 \times LC2 + 1.35 \times LC3 + 1.5 \times LC51 + 1.05 \times LC10031 + 1 + 1.05 \times LC10101$
max N	ELUmaxN	$1.35 \times LC1 + 1.35 \times LC2 + 1.35 \times LC3 + 1.5 \times LC51 + 0.75 \times LC202 + 0.75 \times LC203 + 0.75 \times LC204 + 0.75 \times LC205$
min M_y	ELUminMy	$1.35 \times LC1 + 1.35 \times LC2 + 1.35 \times LC3 + 1.5 \times LC51 + 0.75 \times LC201 + 1.05 \times LC1326 + 1.05 \times LC10031 + 1 + 1.05 \times LC10101$
min M_z	ELUminMz	$1.35 \times LC1 + 1.35 \times LC2 + 1.35 \times LC3 + 1.5 \times LC10121 + 0.9 \times LC101 + 0.75 \times LC201 + 0.75 \times LC202 + 1.05 \times LC1326 + 1.5 \times LC10021$
min V_y	ELUminVy	$1.35 \times LC1 + 1.35 \times LC2 + 1.35 \times LC3 + 1.5 \times LC10121 + 0.75 \times LC201 + 0.75 \times LC202 + 1.05 \times LC1356 + 1.05 \times LC10021$
min V_z	ELUminVz	$1.35 \times LC1 + 1.35 \times LC2 + 1.35 \times LC3 + 1.5 \times LC101 + 0.75 \times LC202 + 0.75 \times LC203 + 0.75 \times LC204 + 0.75 \times LC205 + 0.75 \times LC206 + 1.05 \times LC10111$
min N	ELUminN	$1.35 \times LC1 + 1.35 \times LC2 + 1.35 \times LC3 + 1.5 \times LC10031 + 1 + 1.5 \times LC1366 + 0.75 \times LC201 + 1.05 \times LC10121$

Table 4: Combinations

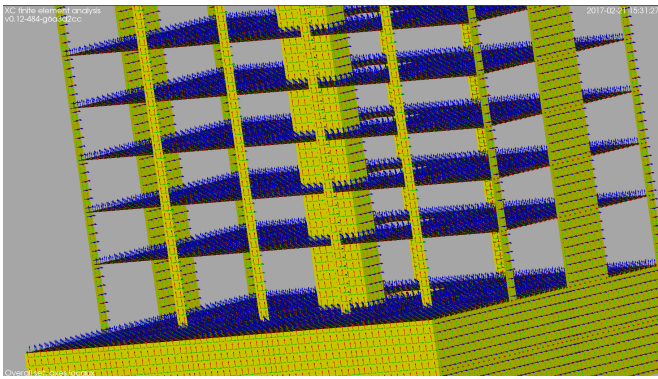

Figure 4: Local axes.

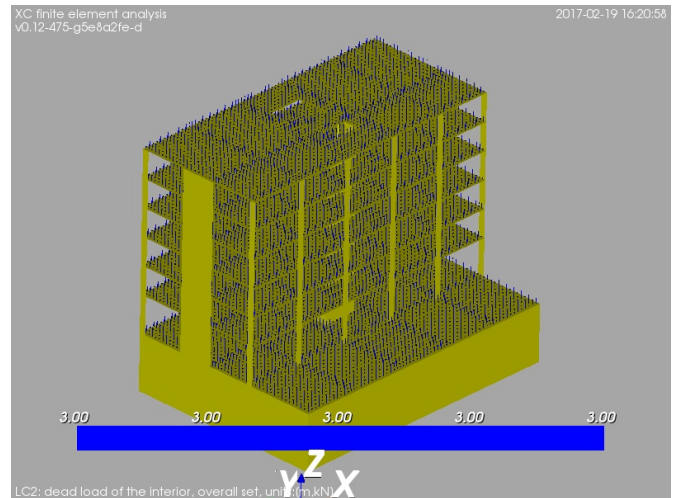

Figure 6: LC2: dead load of the interior, overall set, units:[m,kN]

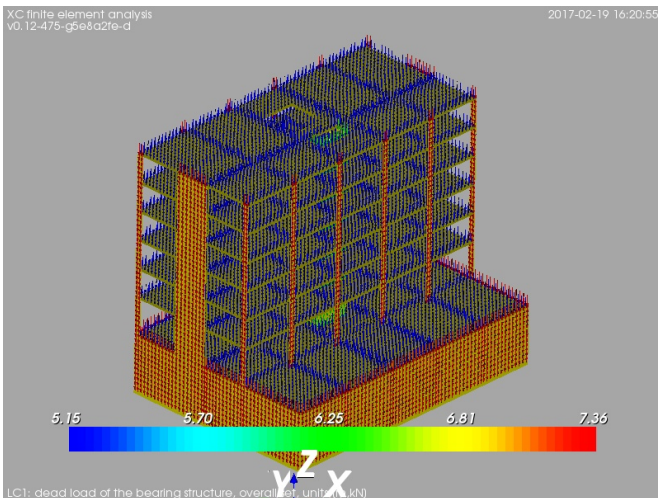

Figure 5: LC1: dead load of the bearing structure, overall set, units:[m,kN]

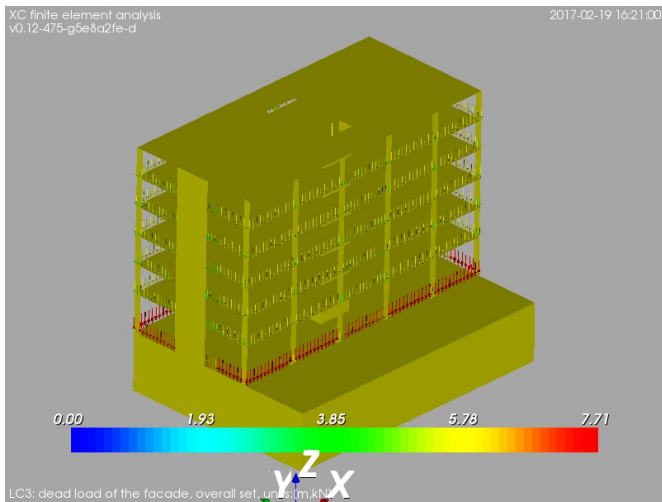

Figure 7: LC3: dead load of the facade, overall set, units:[m,kN]

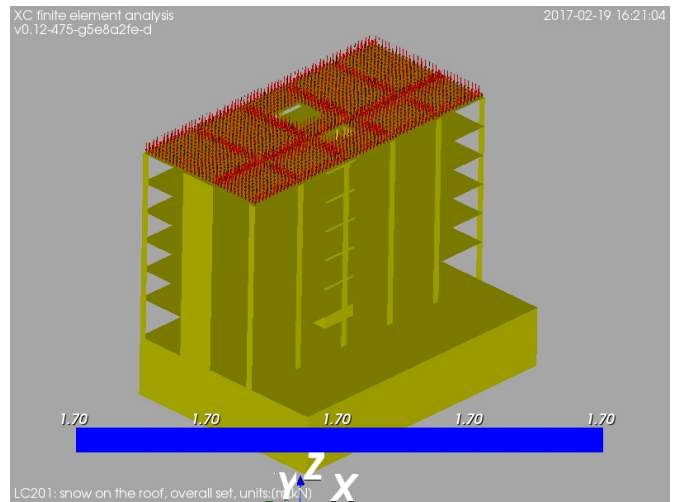

Figure 10: LC201: snow on the roof, overall set, units:[m,kN]

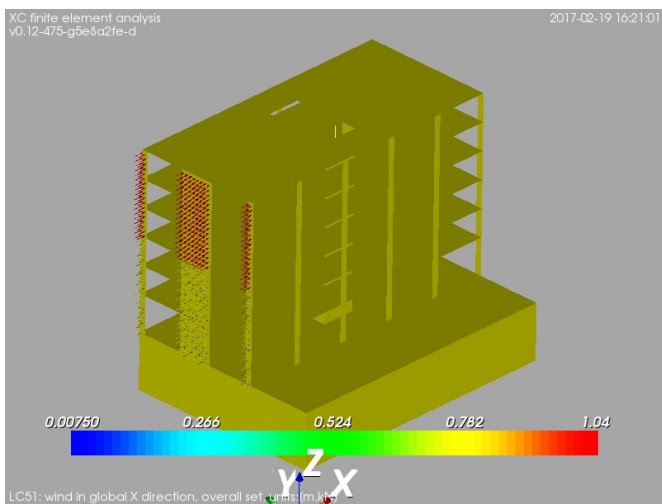

Figure 8: LC51: wind in global X direction, overall set, units:[m,kN]

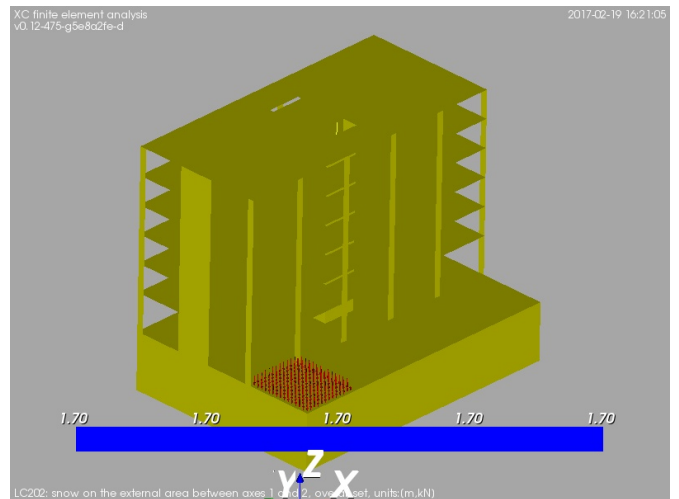

Figure 11: LC202: snow on the external area between axes 1 and 2, overall set, units:[m,kN]

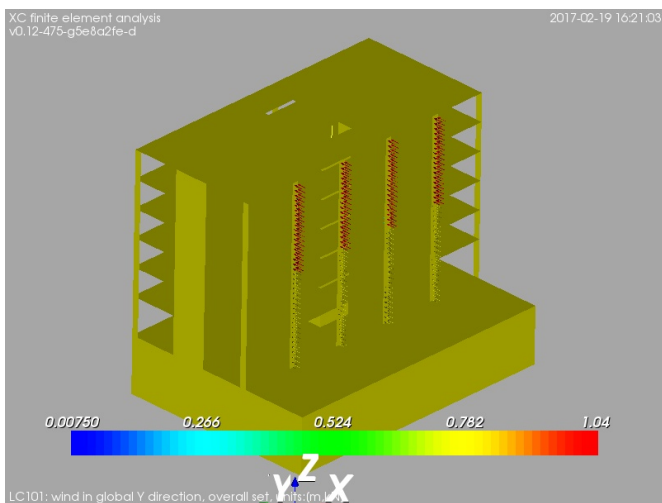

Figure 9: LC101: wind in global Y direction, overall set, units:[m,kN]

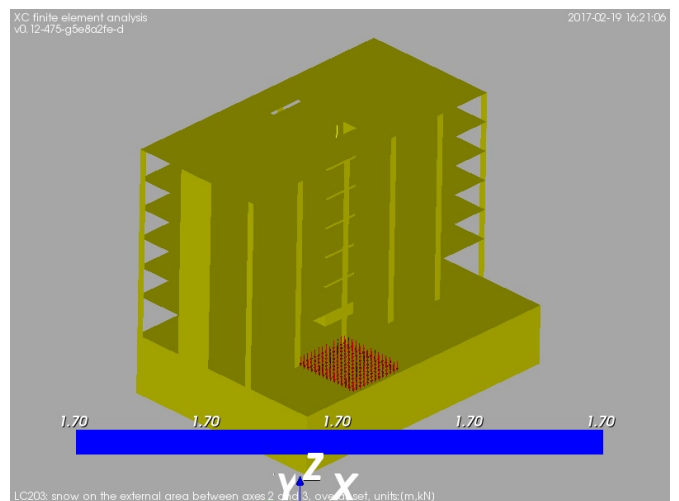

Figure 12: LC203: snow on the external area between axes 2 and 3, overall set, units:[m,kN]

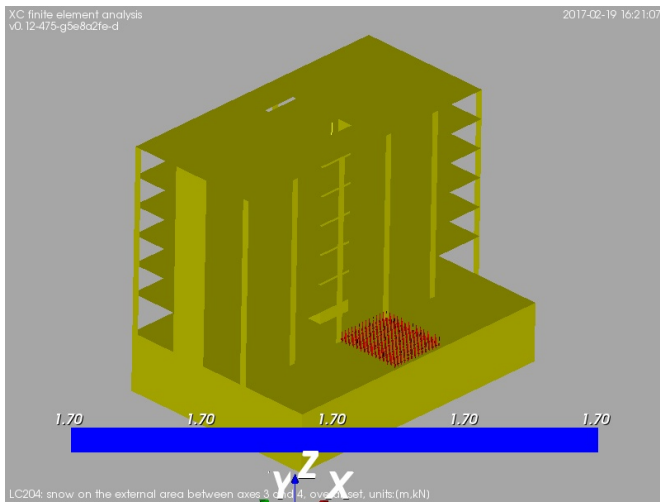

Figure 13: LC204: snow on the external area between axes 3 and 4, overall set, units:[m,kN]

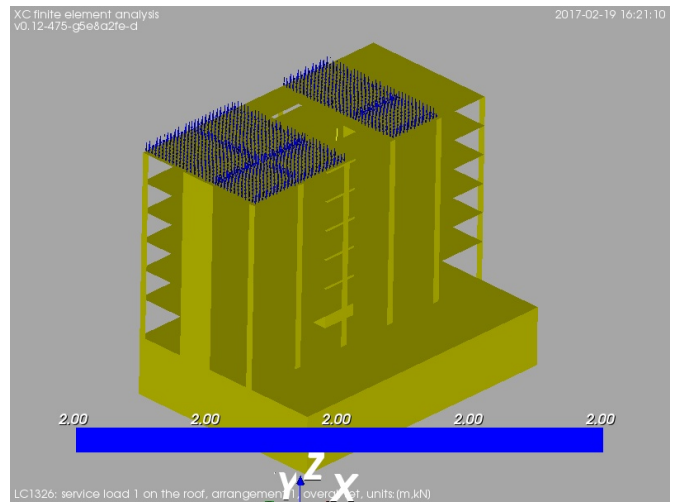

Figure 16: LC1326: service load 1 on the roof, arrangement 1, overall set, units:[m,kN]

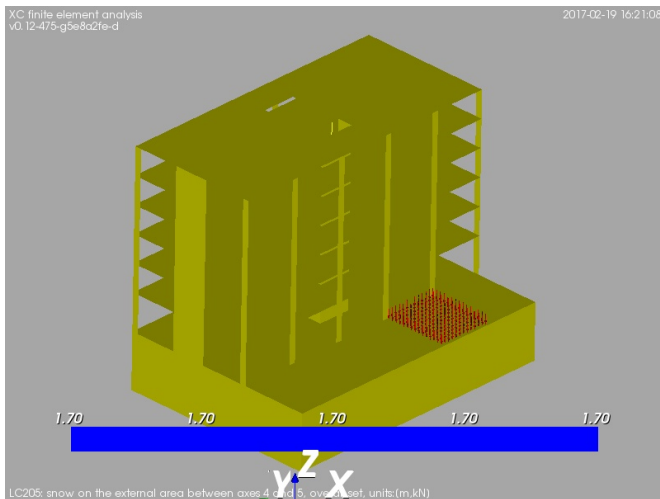

Figure 14: LC205: snow on the external area between axes 4 and 5, overall set, units:[m,kN]

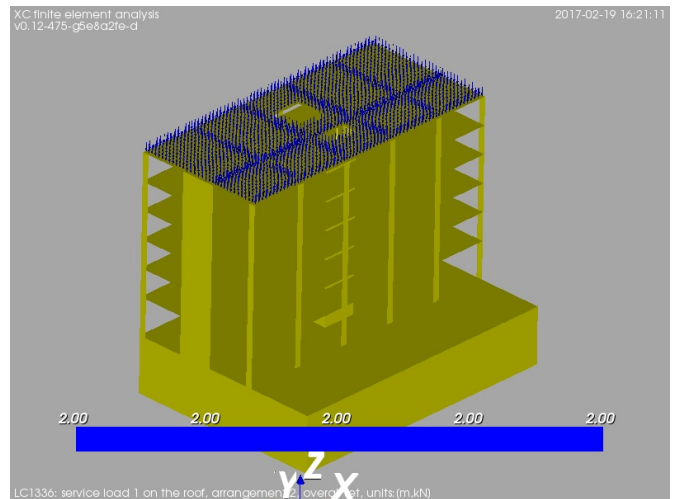

Figure 17: LC1336: service load 1 on the roof, arrangement 2, overall set, units:[m,kN]

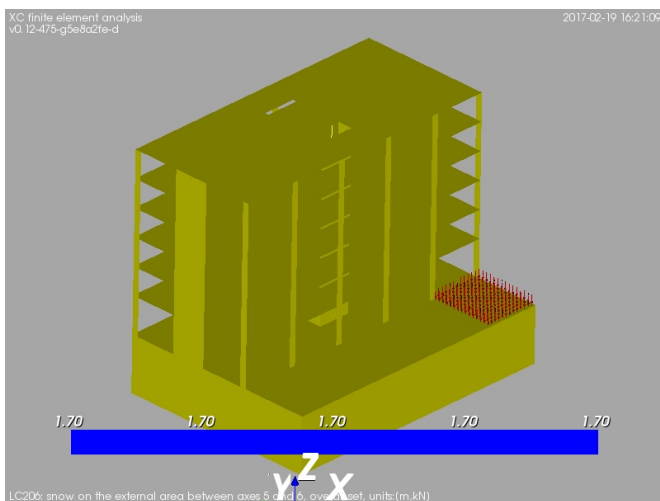

Figure 15: LC206: snow on the external area between axes 5 and 6, overall set, units:[m,kN]

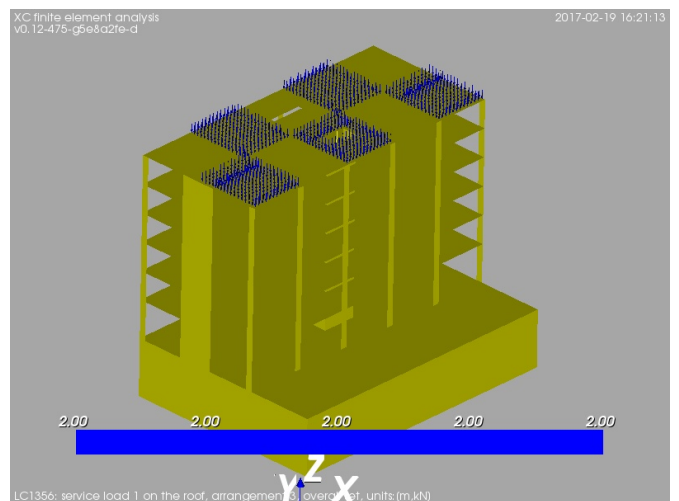

Figure 18: LC1356: service load 1 on the roof, arrangement 3, overall set, units:[m,kN]

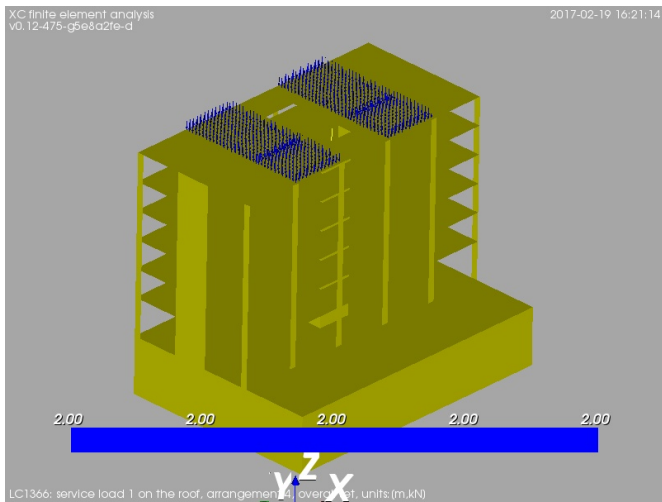

Figure 19: LC1366: service load 1 on the roof, arrangement 4, overall set, units:[m,kN]

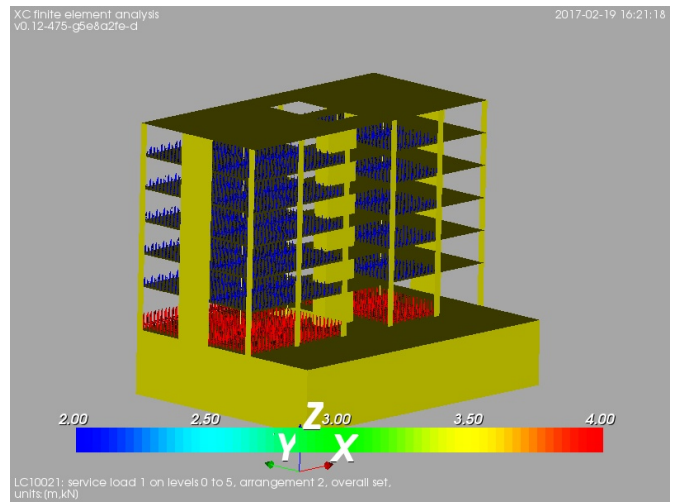

Figure 22: LC10021: service load 1 on levels 0 to 5, arrangement 3, overall set, units:[m,kN]

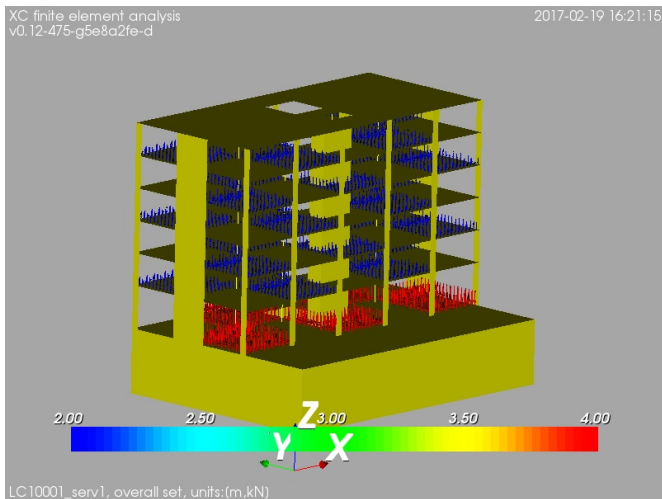

Figure 20: LC10001: service load 1 on levels 0 to 5, arrangement 1, overall set, units:[m,kN]

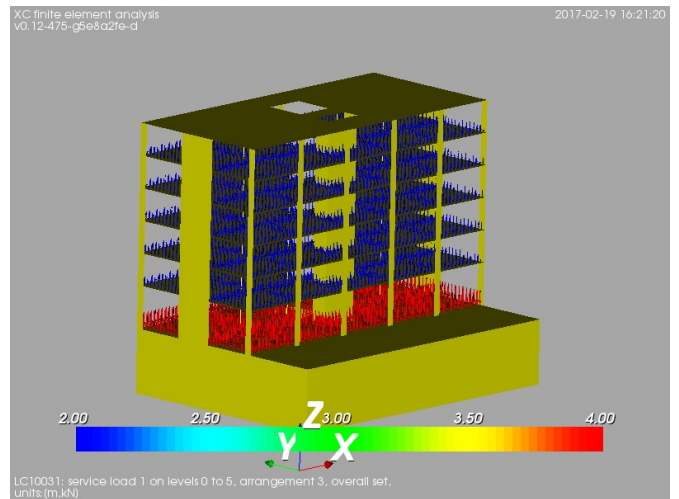

Figure 23: LC10031: service load 1 on levels 0 to 5, arrangement 4, overall set, units:[m,kN]

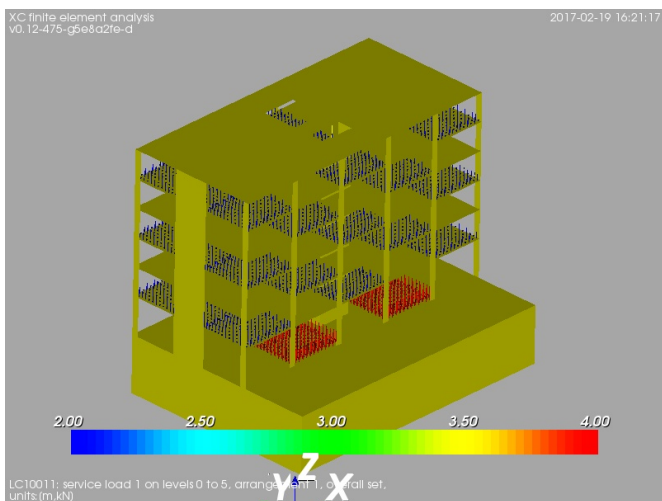

Figure 21: LC10011: service load 1 on levels 0 to 5, arrangement 2, overall set, units:[m,kN]

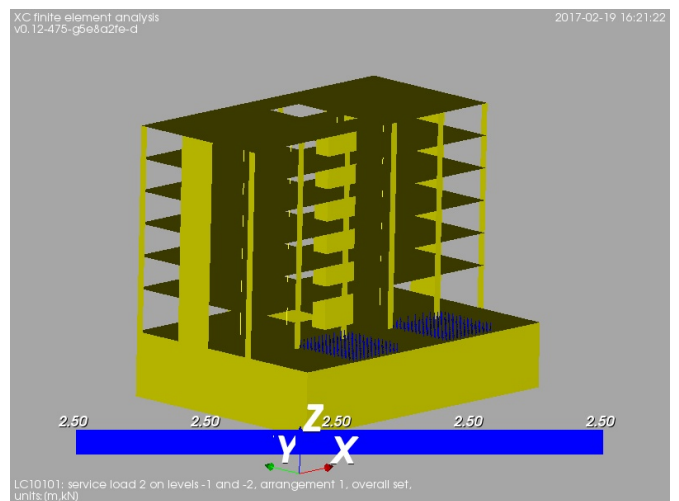

Figure 24: LC10101: service load 2 on levels -1 and -2, arrangement 1, overall set, units:[m,kN]

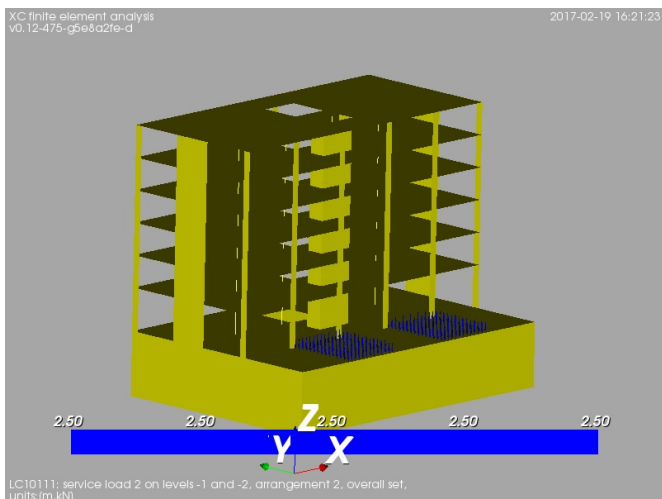

Figure 25: LC10111: service load 2 on levels -1 and -2, arrangement 2, overall set, units:[m,kN]

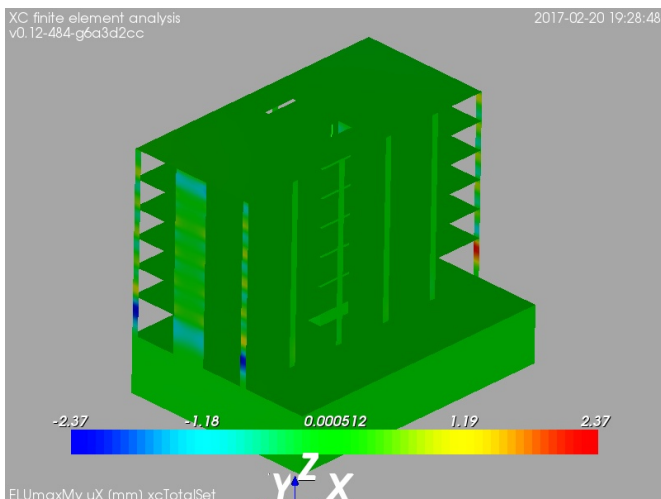

Figure 28: ELUmaxMy: maximum internal moment My. Overall set, displacement in global X direction [mm]

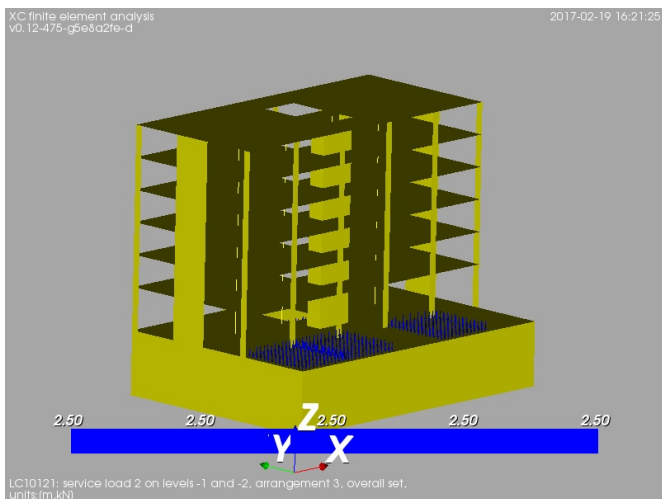

Figure 26: LC10121: service load 2 on levels -1 and -2, arrangement 3, overall set, units:[m,kN]

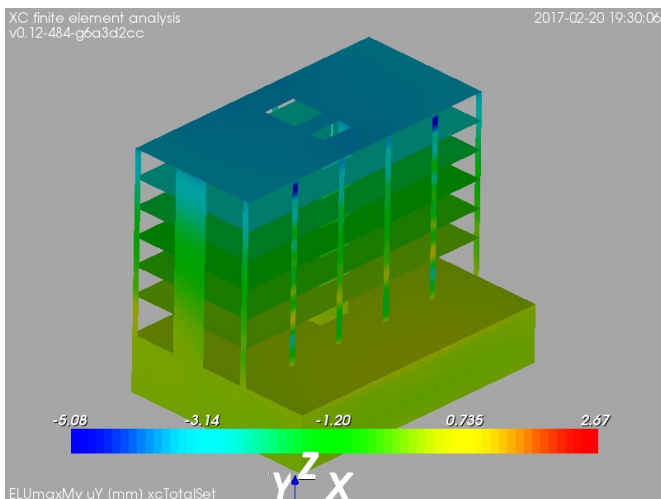

Figure 29: ELUmaxMy: maximum internal moment My. Overall set, displacement in global Y direction [mm]

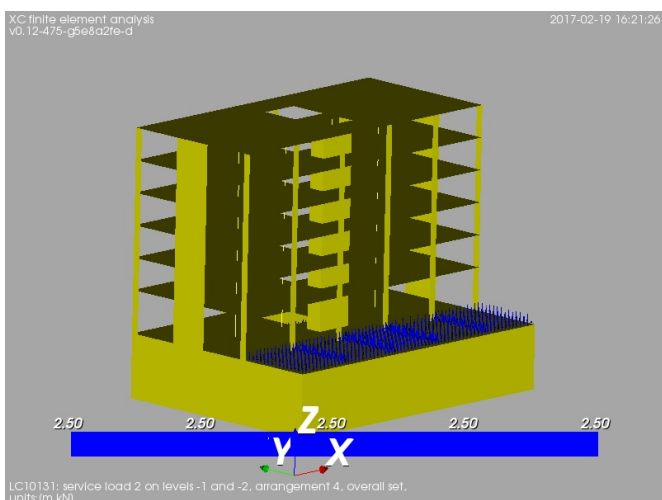

Figure 27: LC10131: service load 2 on levels -1 and -2, arrangement 4, overall set, units:[m,kN]

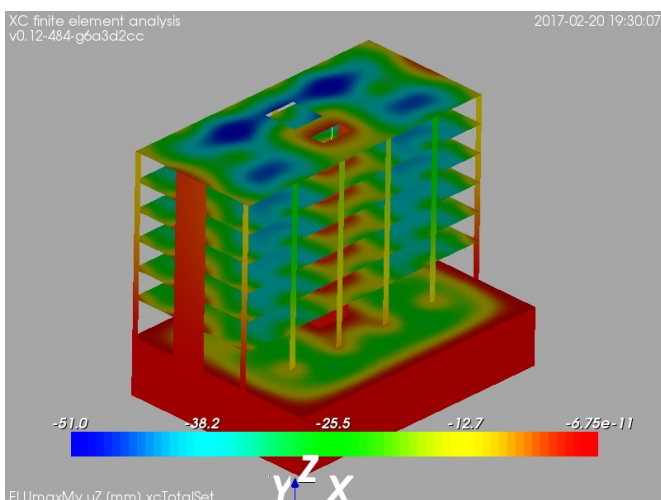

Figure 30: ELUmaxMy: maximum internal moment My. Overall set, displacement in global Z direction [mm]

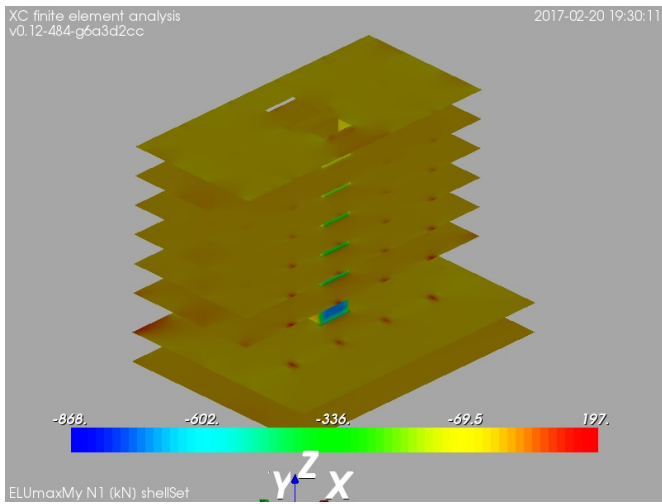

Figure 31: ELUmaxMy: maximum internal moment M_y . Shell elements, internal axial force in local direction 1 [kN]

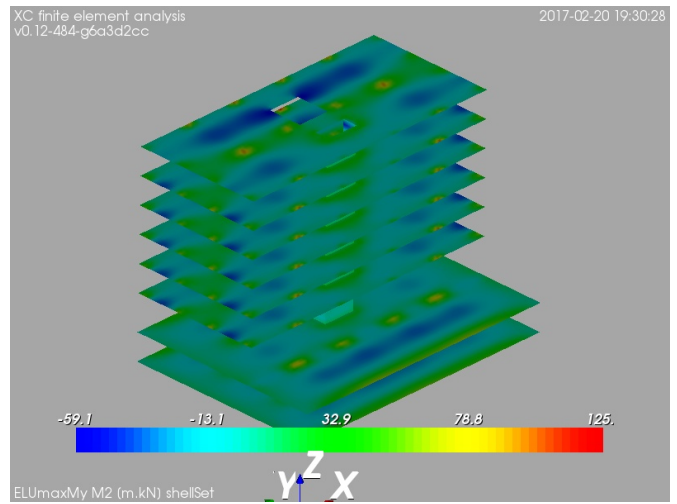

Figure 34: ELUmaxMy: maximum internal moment M_y . Shell elements, bending moment around local axis 2 [m.kN]

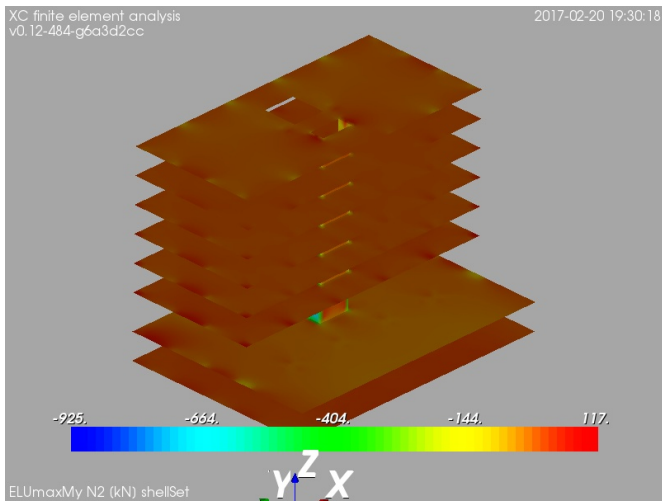

Figure 32: ELUmaxMy: maximum internal moment M_y . Shell elements, internal axial force in local direction 2 [kN]

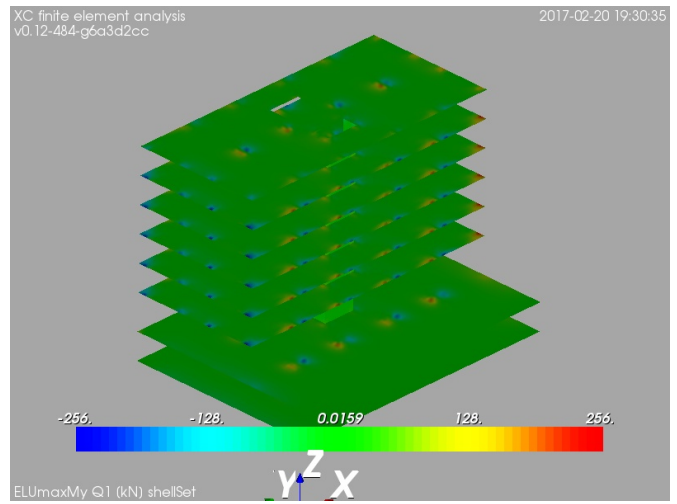

Figure 35: ELUmaxMy: maximum internal moment M_y . Shell elements, internal shear force in local direction 1 [kN]

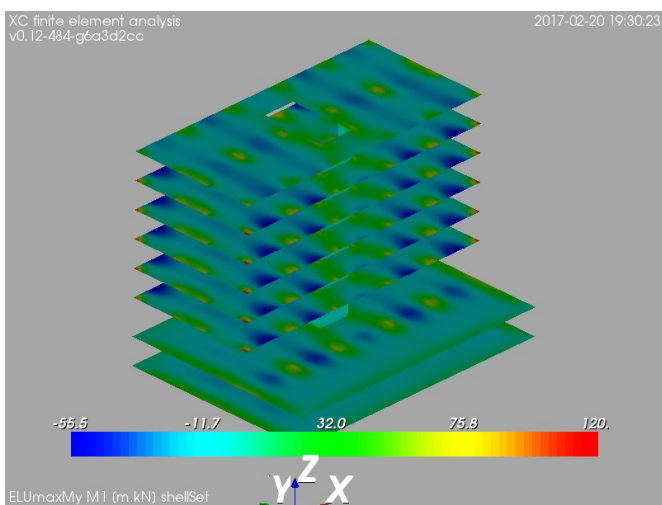

Figure 33: ELUmaxMy: maximum internal moment M_y . Shell elements, bending moment around local axis 1 [m.kN]

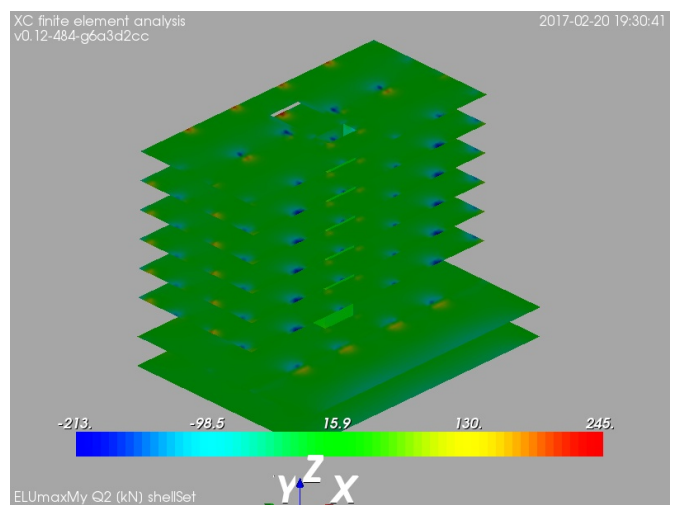

Figure 36: ELUmaxMy: maximum internal moment M_y . Shell elements, internal shear force in local direction 2 [kN]

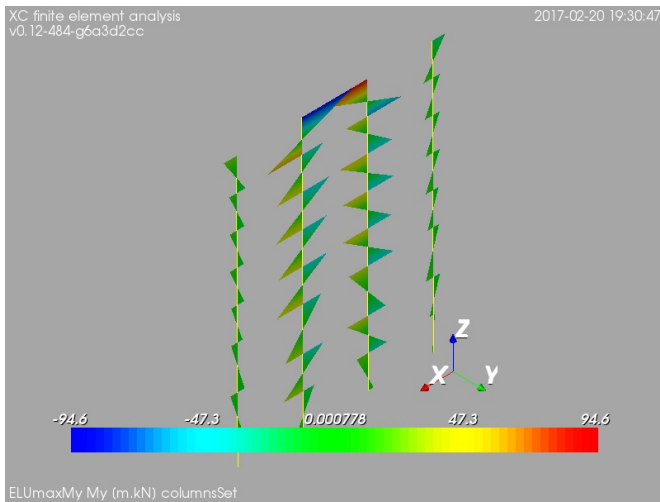

Figure 37: ELUmaxMy: maximum internal moment M_y . Inner columns, bending moment around local axis y [m.kN]

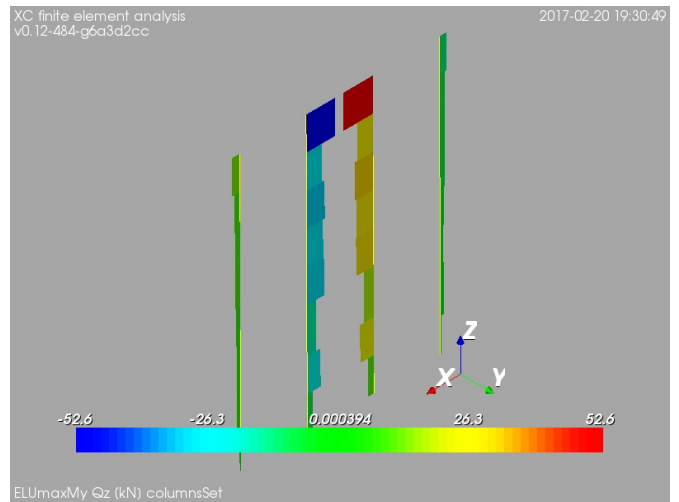

Figure 40: ELUmaxMy: maximum internal moment M_y . Inner columns, internal shear force in local direction z [kN]

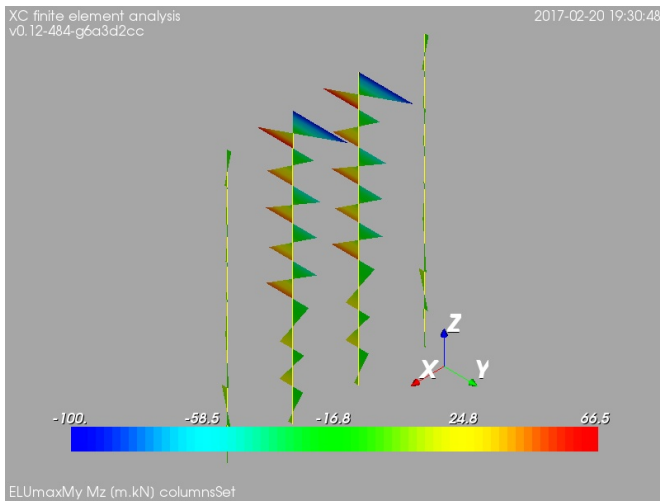

Figure 38: ELUmaxMy: maximum internal moment M_y . Inner columns, bending moment around local axis z [m.kN]

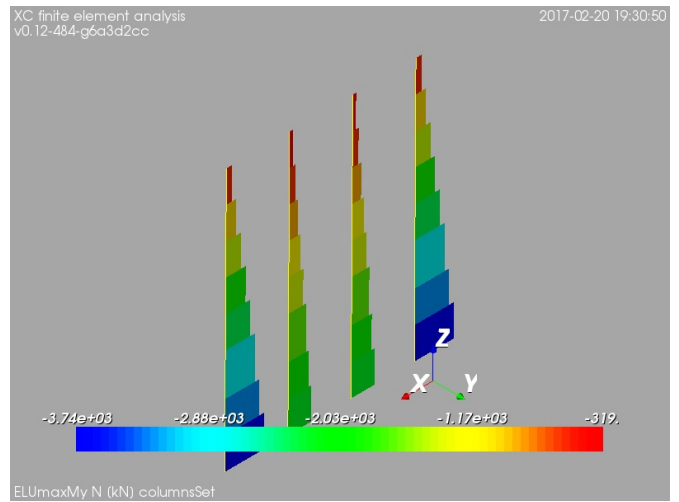

Figure 41: ELUmaxMy: maximum internal moment M_y . Inner columns, internal axial force [kN]

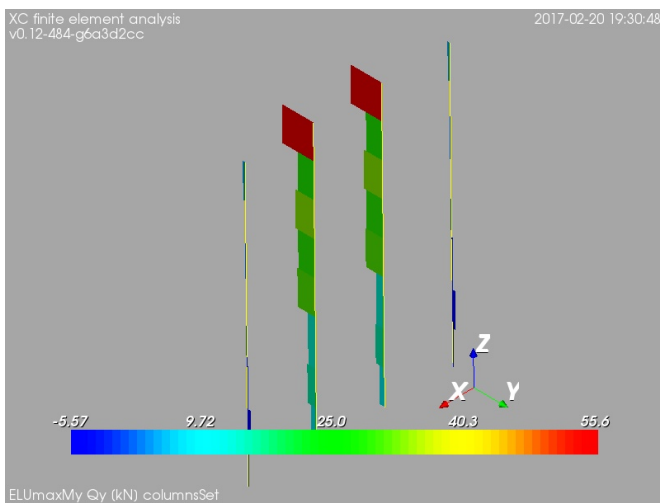

Figure 39: ELUmaxMy: maximum internal moment M_y . Inner columns, internal shear force in local direction y [kN]

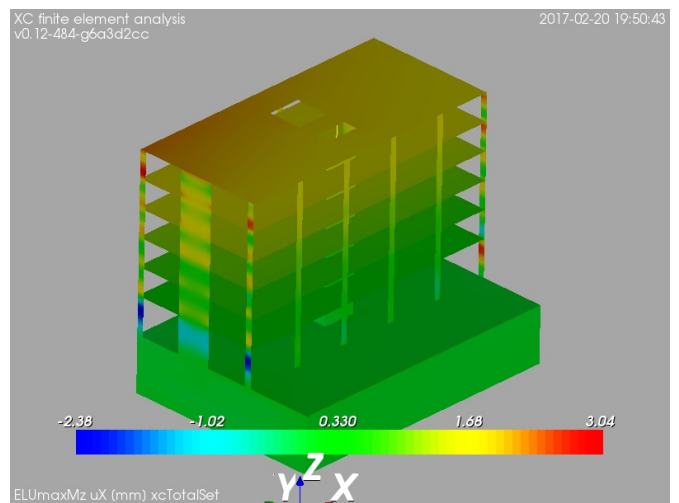

Figure 42: ELUmaxMz: maximum internal moment M_z . Overall set, displacement in global X direction [mm]

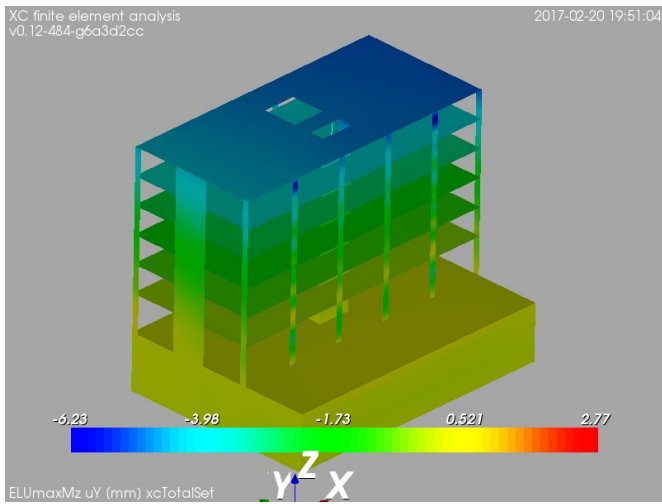

Figure 43: ELUmaxMz: maximum internal moment M_z . Overall set, displacement in global Y direction [mm]

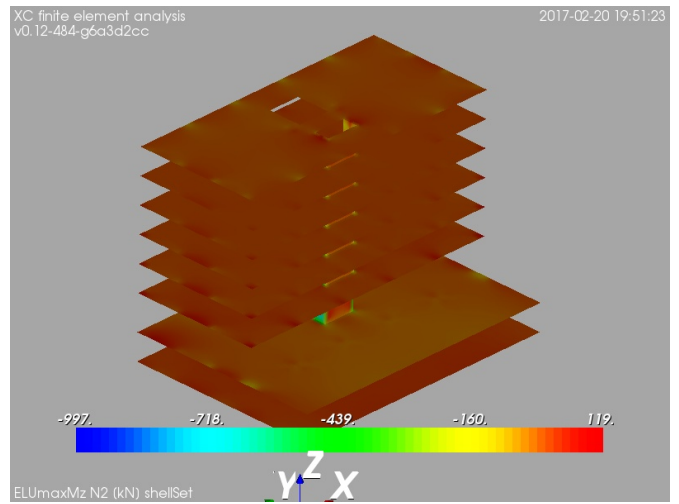

Figure 46: ELUmaxMz: maximum internal moment M_z . Shell elements, internal axial force in local direction 2 [kN]

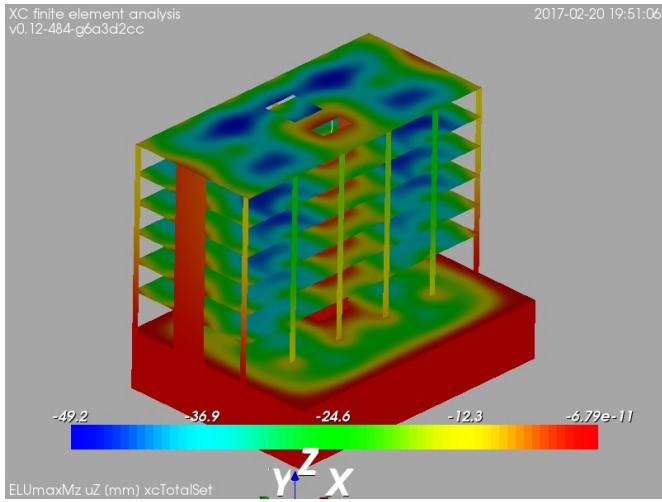

Figure 44: ELUmaxMz: maximum internal moment M_z . Overall set, displacement in global Z direction [mm]

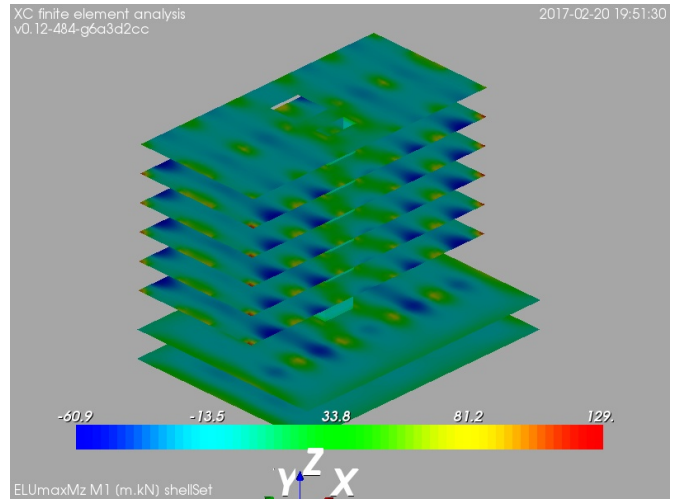

Figure 47: ELUmaxMz: maximum internal moment M_z . Shell elements, bending moment around local axis 1 [m.kN]

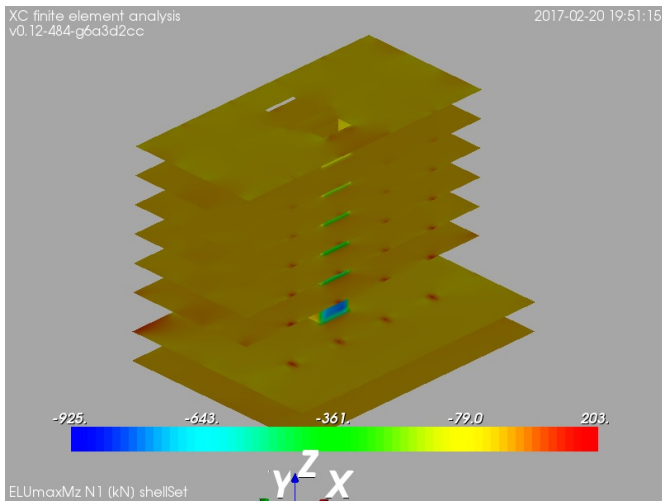

Figure 45: ELUmaxMz: maximum internal moment M_z . Shell elements, internal axial force in local direction 1 [kN]

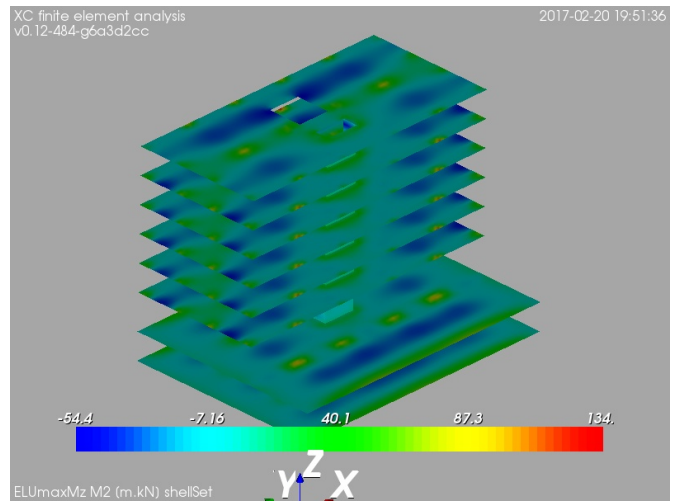

Figure 48: ELUmaxMz: maximum internal moment M_z . Shell elements, bending moment around local axis 2 [m.kN]

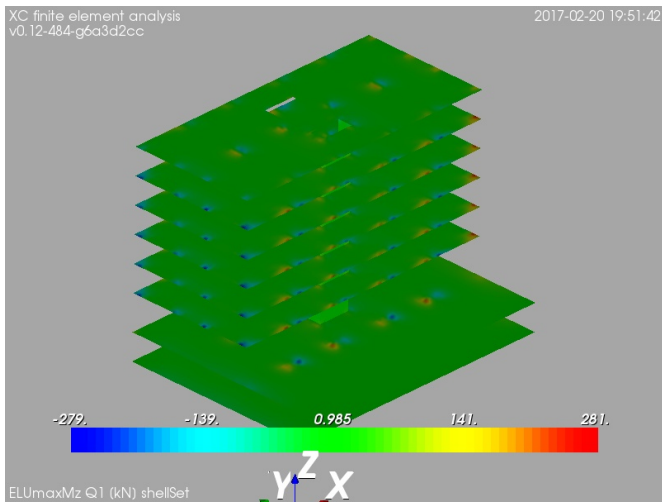

Figure 49: ELUmaxMz: maximum internal moment M_z . Shell elements, internal shear force in local direction 1 [kN]

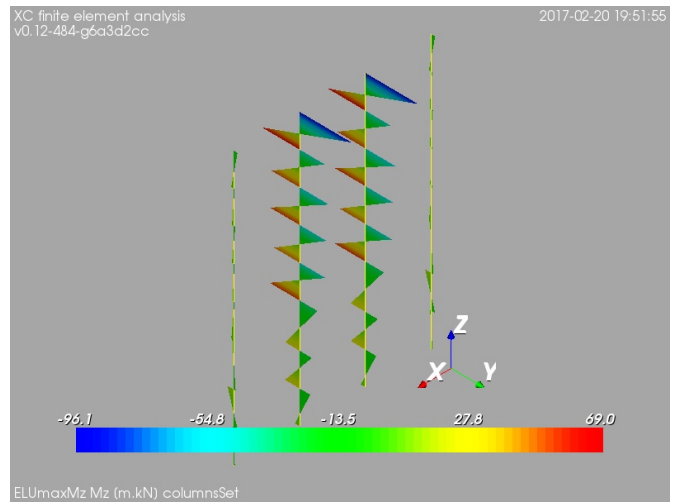

Figure 52: ELUmaxMz: maximum internal moment M_z . Inner columns, bending moment around local axis z [m.kN]

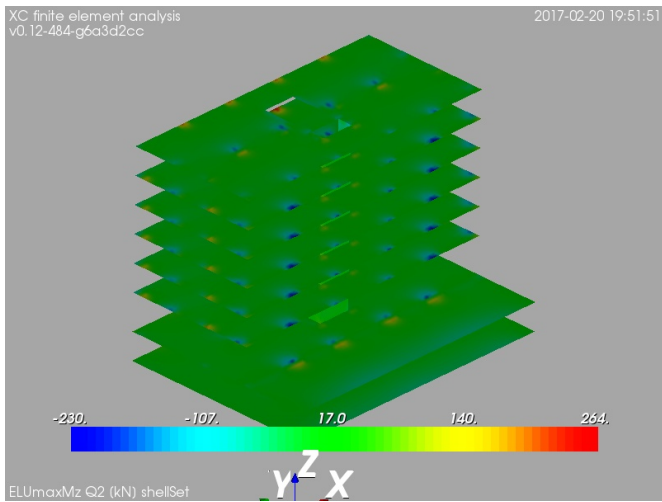

Figure 50: ELUmaxMz: maximum internal moment M_z . Shell elements, internal shear force in local direction 2 [kN]

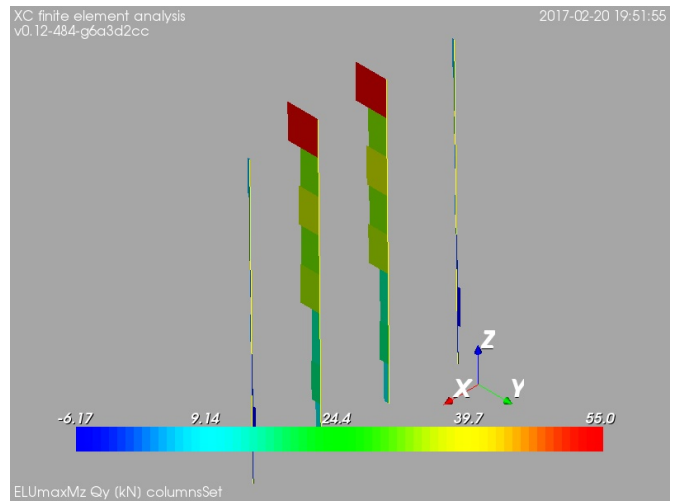

Figure 53: ELUmaxMz: maximum internal moment M_z . Inner columns, internal shear force in local direction y [kN]

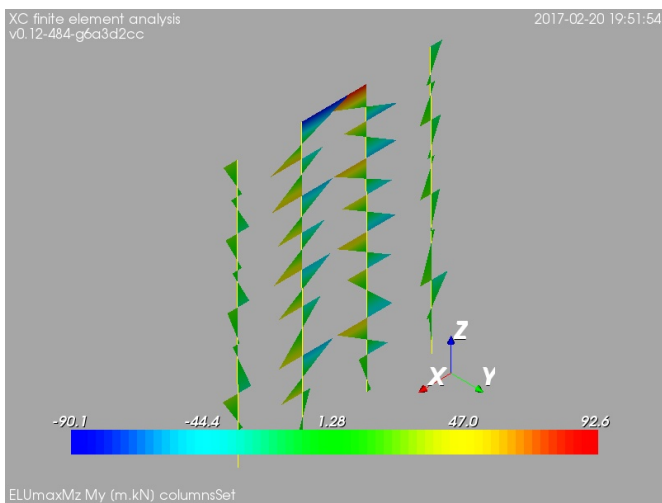

Figure 51: ELUmaxMz: maximum internal moment M_z . Inner columns, bending moment around local axis y [m.kN]



Figure 54: ELUmaxMz: maximum internal moment M_z . Inner columns, internal shear force in local direction z [kN]

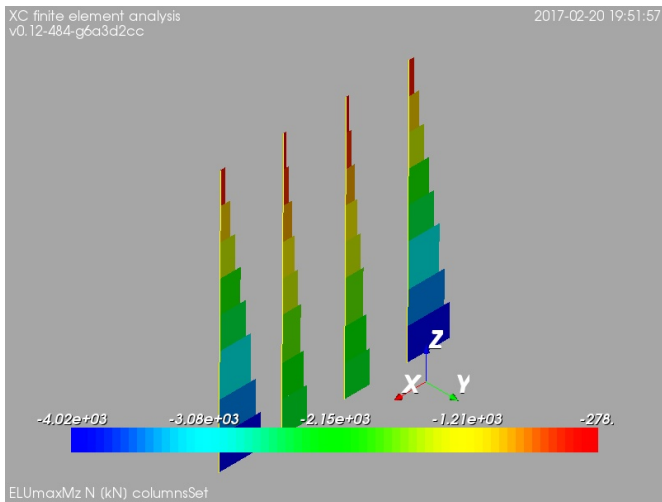

Figure 55: ELUmaxMz: maximum internal moment M_z . Inner columns, internal axial force [kN]

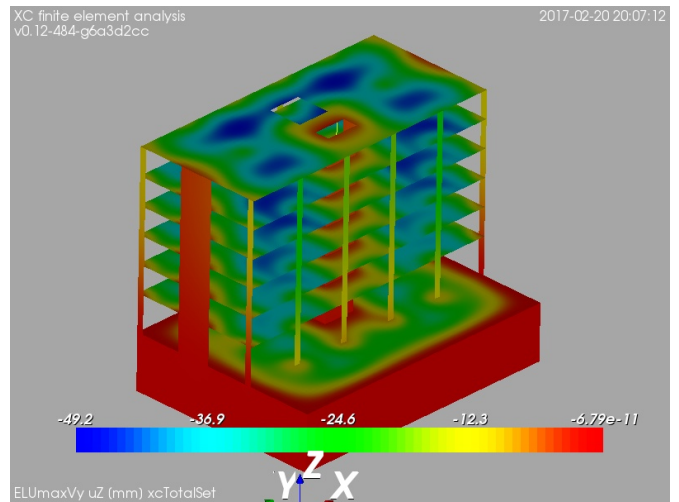

Figure 58: ELUmaxVy: maximum internal force V_y . Overall set, displacement in global Z direction [mm]

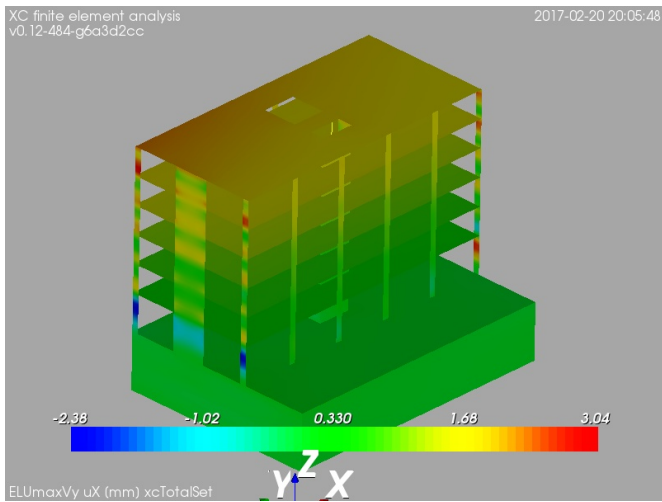

Figure 56: ELUmaxVy: maximum internal force V_y . Overall set, displacement in global X direction [mm]

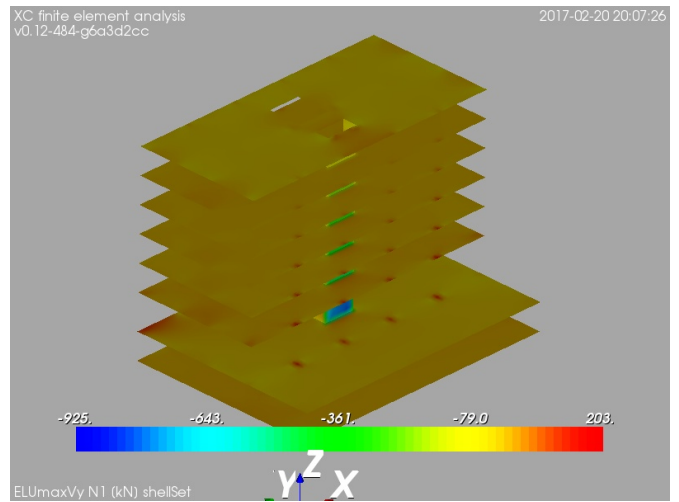

Figure 59: ELUmaxVy: maximum internal force V_y . Shell elements, internal axial force in local direction 1 [kN]

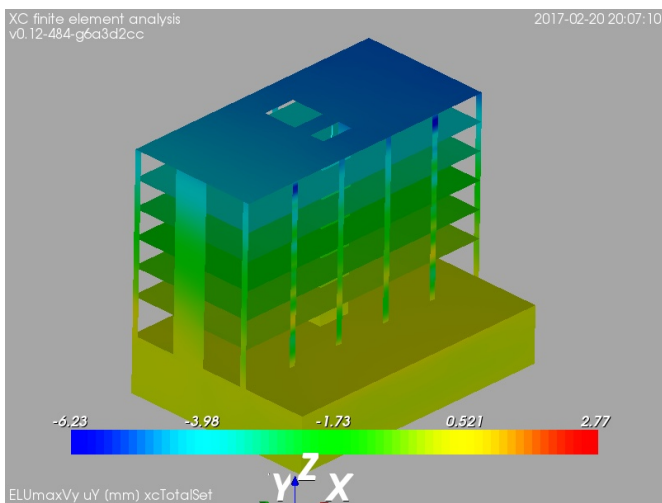

Figure 57: ELUmaxVy: maximum internal force V_y . Overall set, displacement in global Y direction [mm]

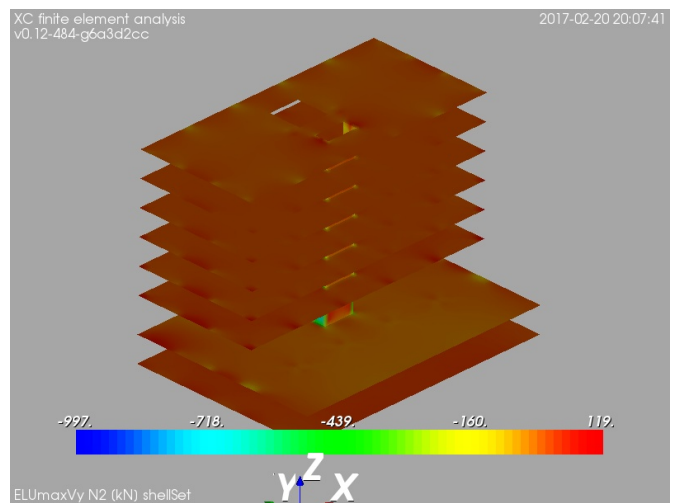

Figure 60: ELUmaxVy: maximum internal force V_y . Shell elements, internal axial force in local direction 2 [kN]

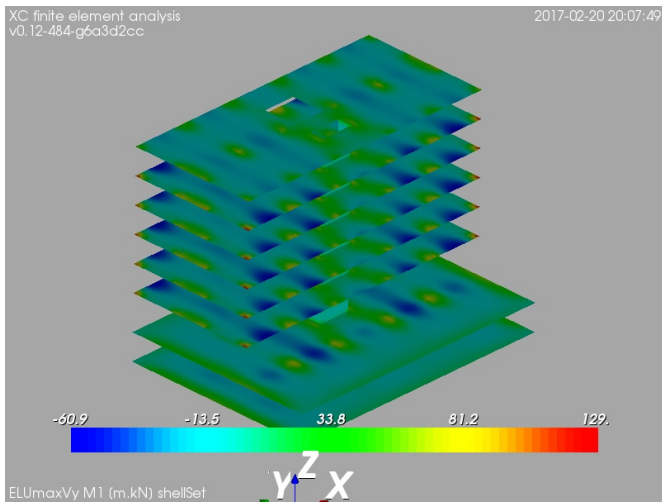

Figure 61: ELUmaxVy: maximum internal force Vy. Shell elements, bending moment around local axis 1 [m.kN]

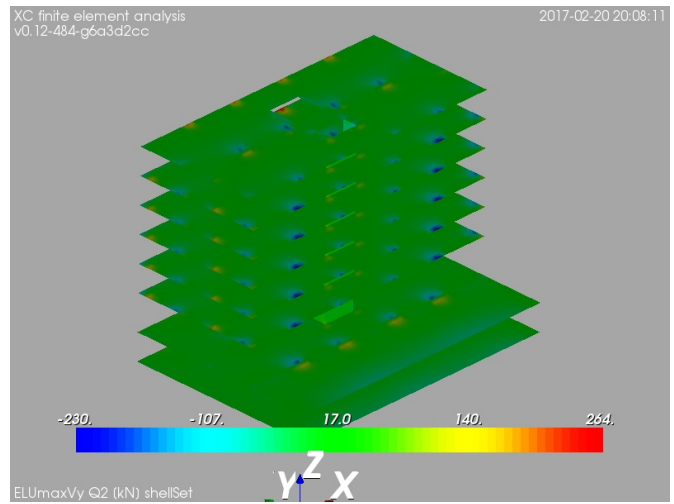

Figure 64: ELUmaxVy: maximum internal force Vy. Shell elements, internal shear force in local direction 2 [kN]

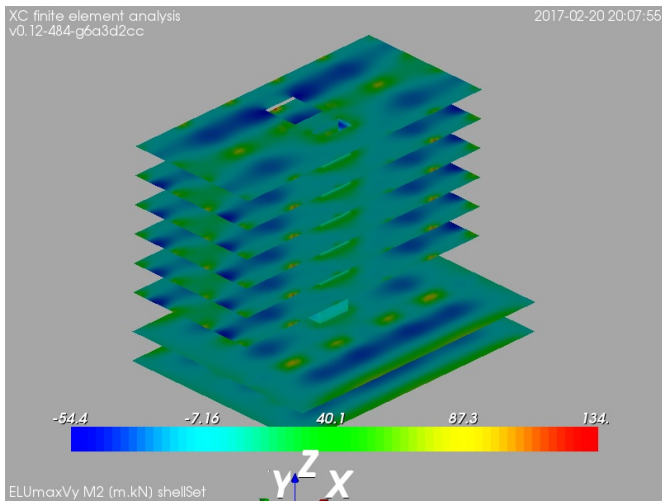

Figure 62: ELUmaxVy: maximum internal force Vy. Shell elements, bending moment around local axis 2 [m.kN]

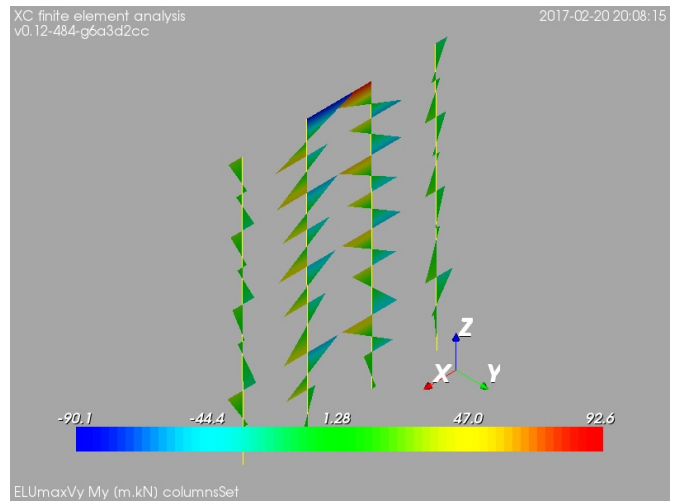

Figure 65: ELUmaxVy: maximum internal force Vy. Inner columns, bending moment around local axis y [m.kN]

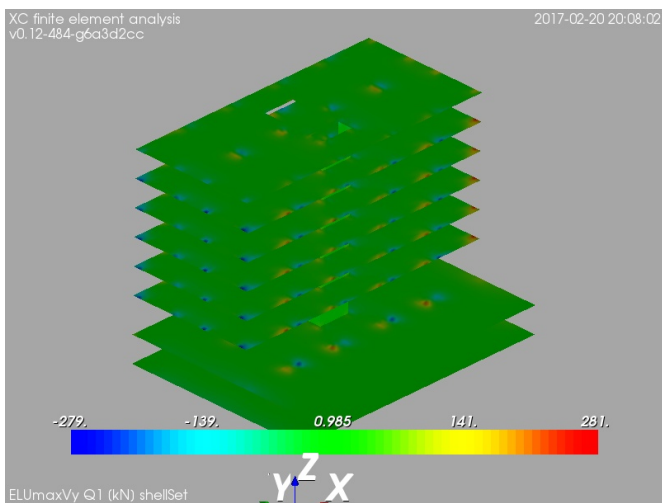

Figure 63: ELUmaxVy: maximum internal force Vy. Shell elements, internal shear force in local direction 1 [kN]

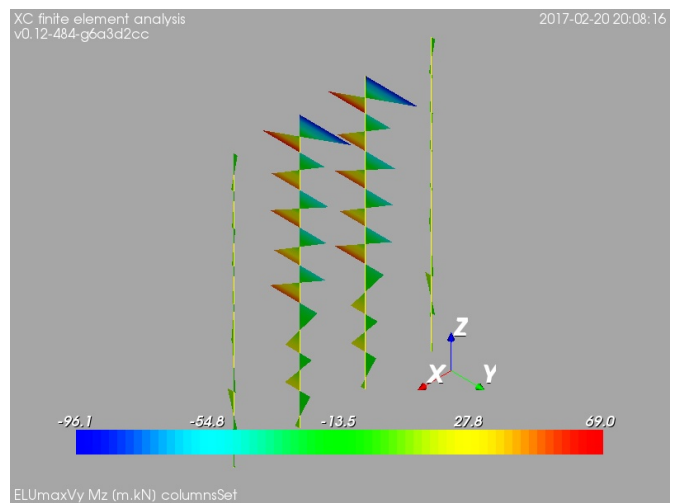

Figure 66: ELUmaxVy: maximum internal force Vy. Inner columns, bending moment around local axis z [m.kN]

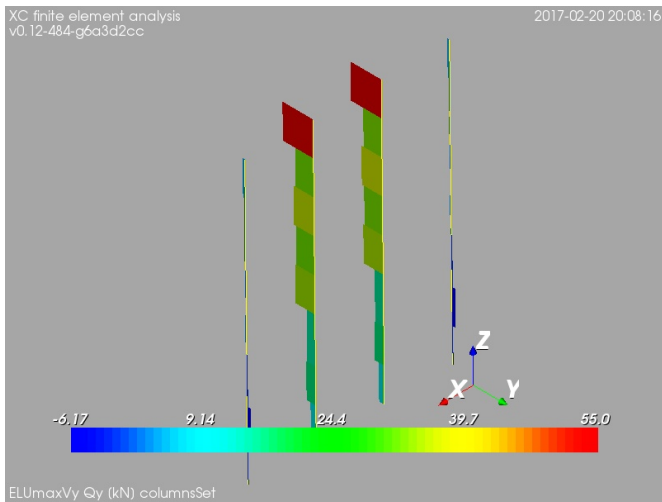

Figure 67: ELUmaxVy: maximum internal force V_y . Inner columns, internal shear force in local direction y [kN]

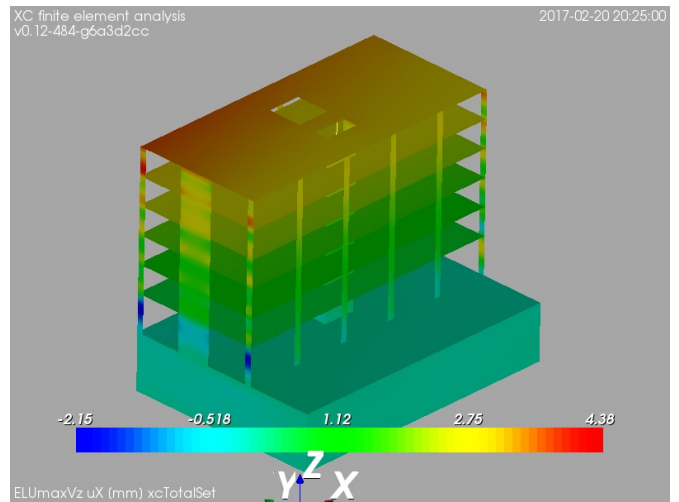

Figure 70: ELUmaxVz: maximum internal force V_z . Overall set, displacement in global X direction [mm]

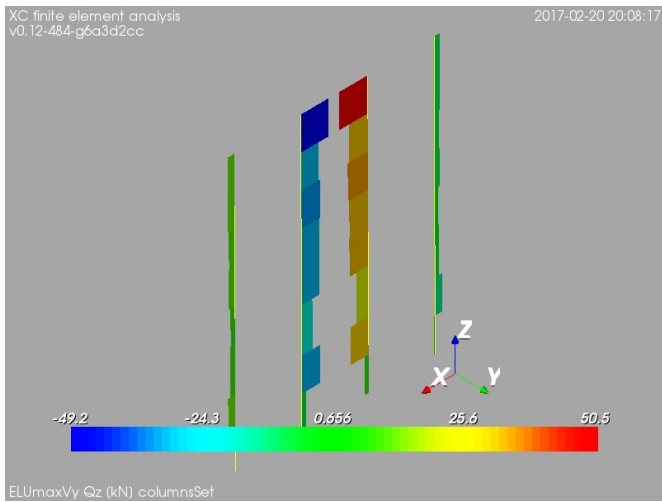

Figure 68: ELUmaxVy: maximum internal force V_y . Inner columns, internal shear force in local direction z [kN]

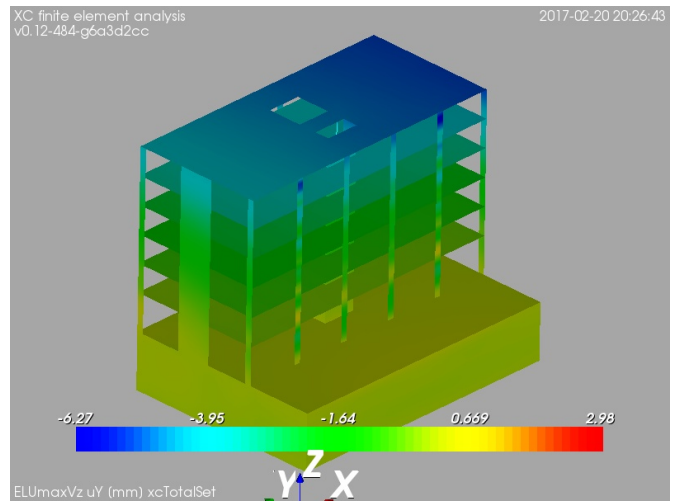

Figure 71: ELUmaxVz: maximum internal force V_z . Overall set, displacement in global Y direction [mm]

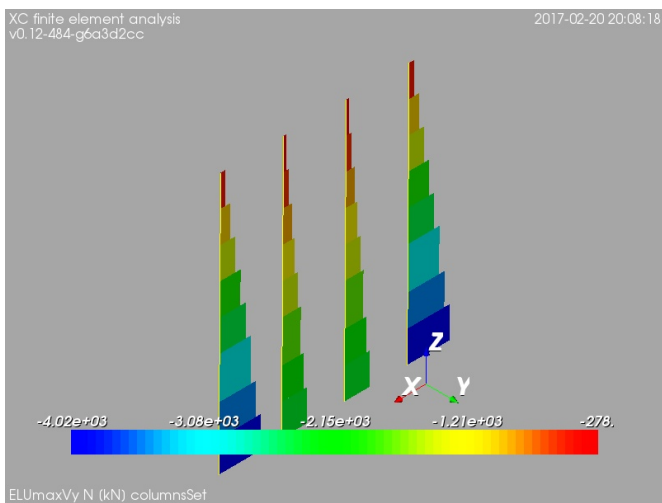

Figure 69: ELUmaxVy: maximum internal force V_y . Inner columns, internal axial force [kN]

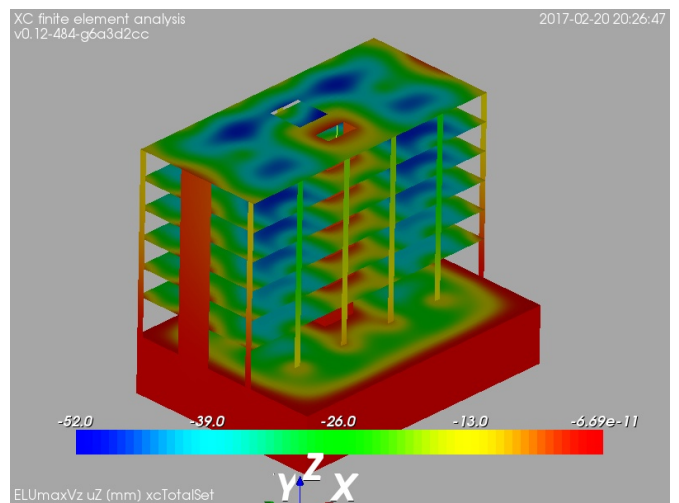

Figure 72: ELUmaxVz: maximum internal force V_z . Overall set, displacement in global Z direction [mm]

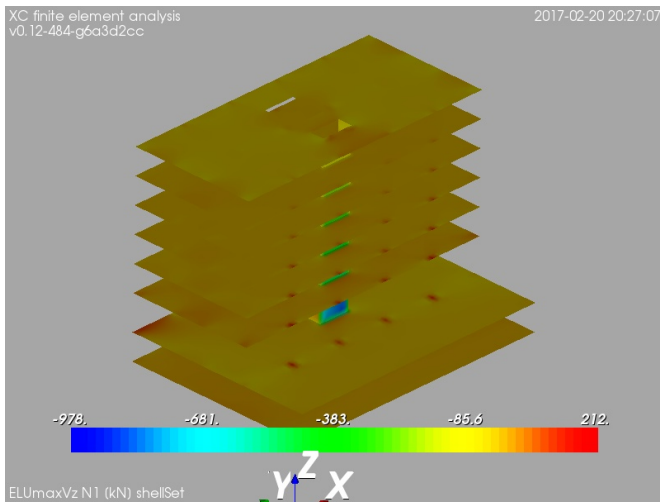

Figure 73: ELUmaxVz: maximum internal force Vz. Shell elements, internal axial force in local direction 1 [kN]

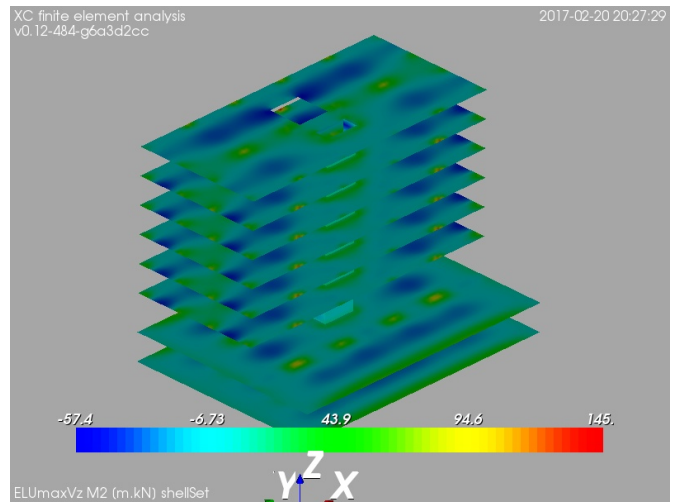

Figure 76: ELUmaxVz: maximum internal force Vz. Shell elements, bending moment around local axis 2 [m.kN]

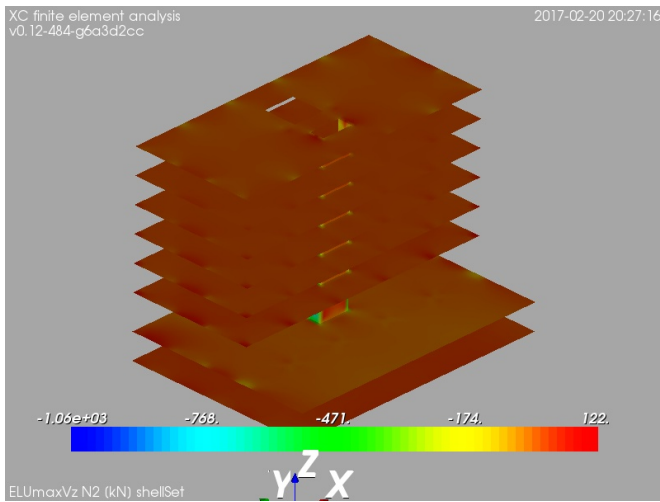

Figure 74: ELUmaxVz: maximum internal force Vz. Shell elements, internal axial force in local direction 2 [kN]

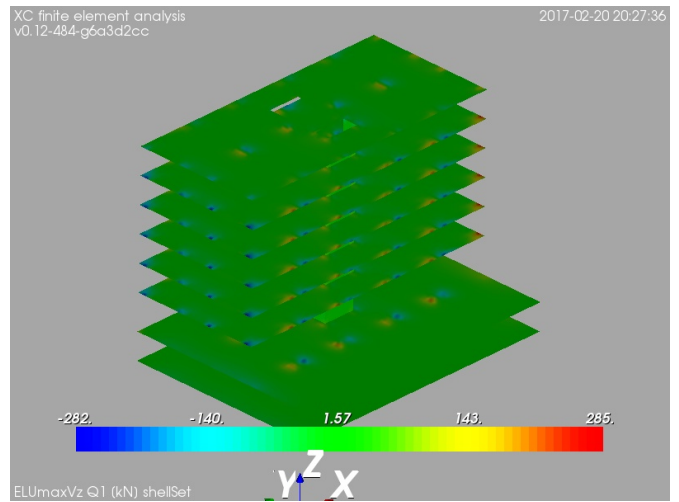

Figure 77: ELUmaxVz: maximum internal force Vz. Shell elements, internal shear force in local direction 1 [kN]

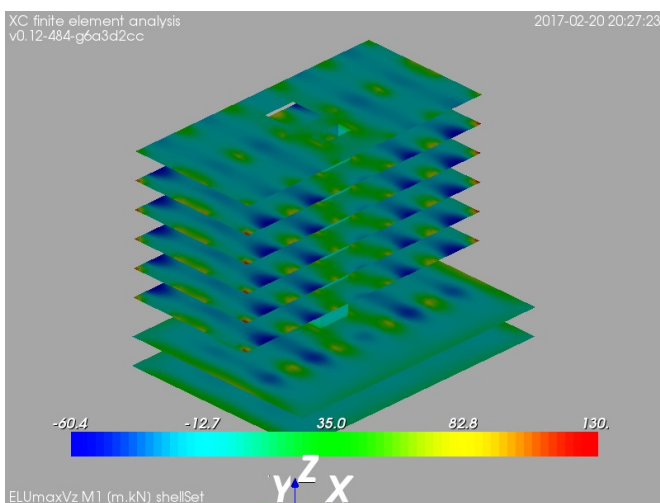

Figure 75: ELUmaxVz: maximum internal force Vz. Shell elements, bending moment around local axis 1 [m.kN]

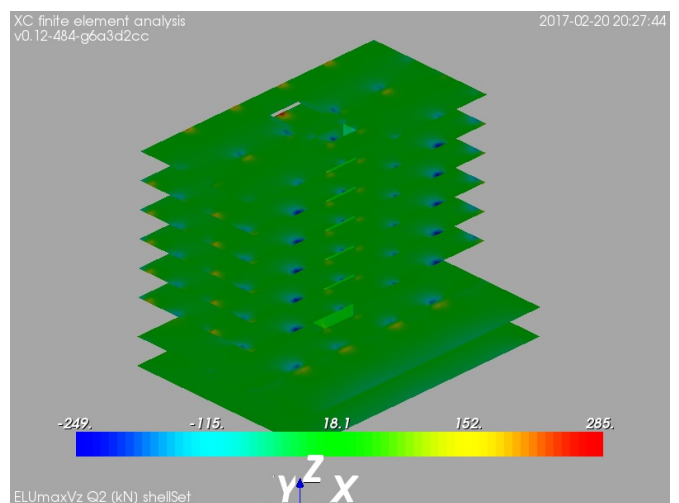

Figure 78: ELUmaxVz: maximum internal force Vz. Shell elements, internal shear force in local direction 2 [kN]

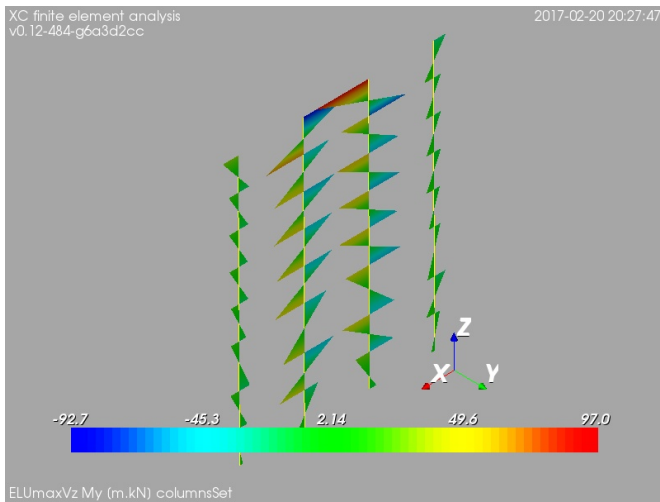

Figure 79: ELUmaxVz: maximum internal force Vz. Inner columns, bending moment around local axis y [m.kN]

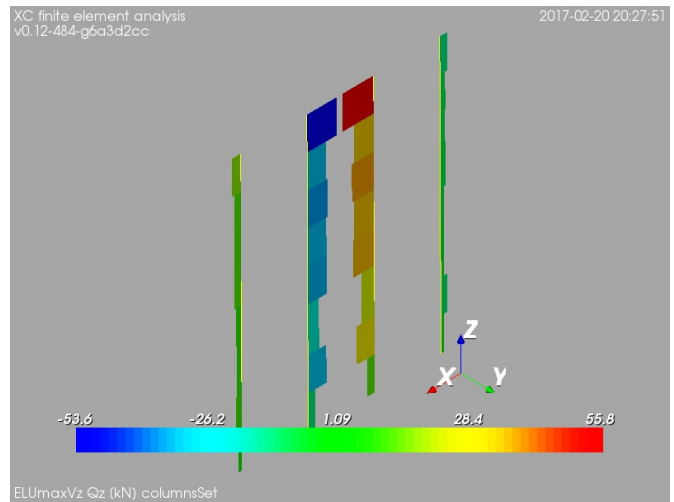

Figure 82: ELUmaxVz: maximum internal force Vz. Inner columns, internal shear force in local direction z [kN]

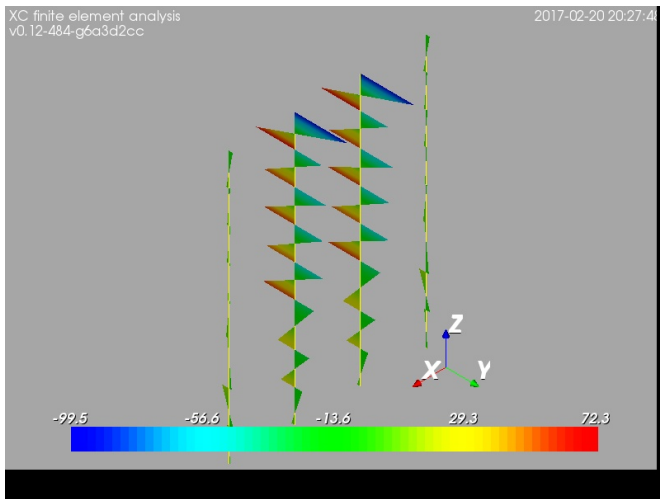

Figure 80: ELUmaxVz: maximum internal force Vz. Inner columns, bending moment around local axis z [m.kN]

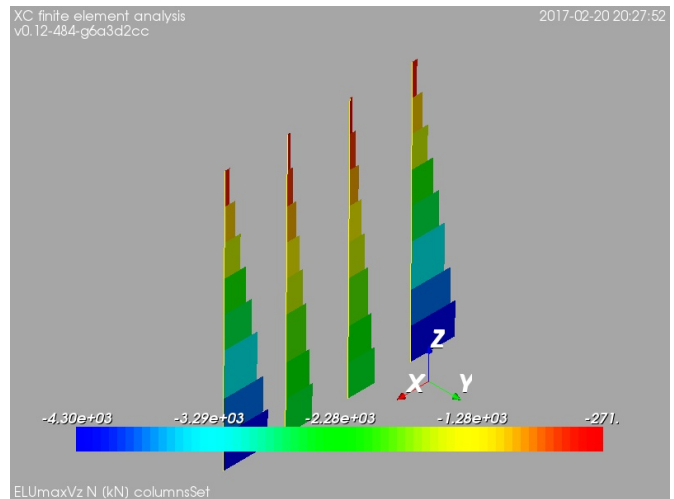

Figure 83: ELUmaxVz: maximum internal force Vz. Inner columns, internal axial force [kN]

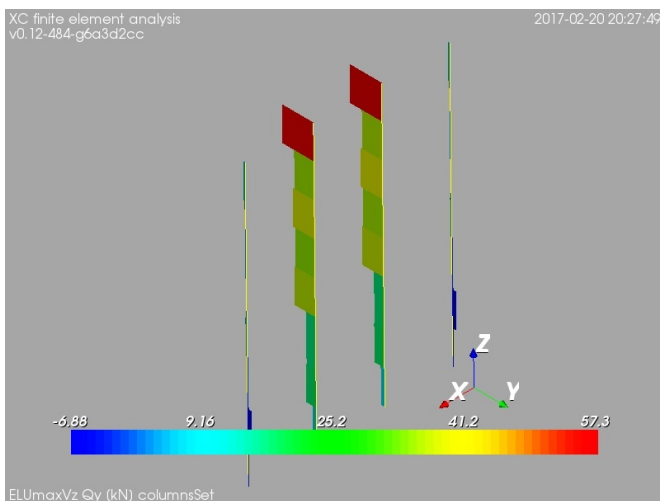

Figure 81: ELUmaxVz: maximum internal force Vz. Inner columns, internal shear force in local direction y [kN]

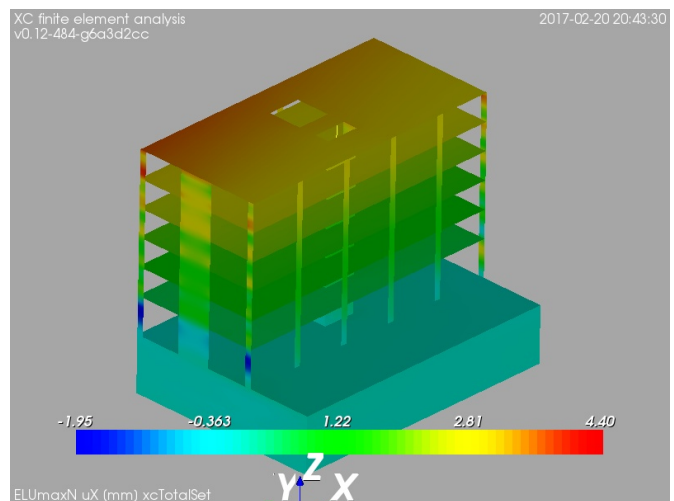

Figure 84: ELUmaxN: maximum internal force N. Overall set, displacement in global X direction [mm]

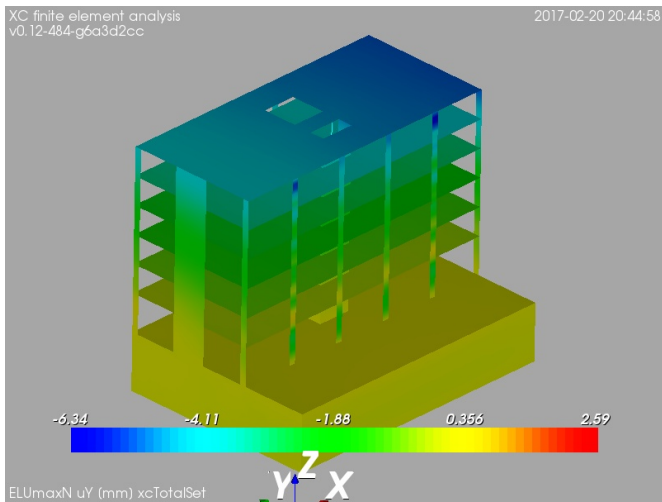

Figure 85: ELUmaxN: maximum internal force N. Overall set, displacement in global Y direction [mm]

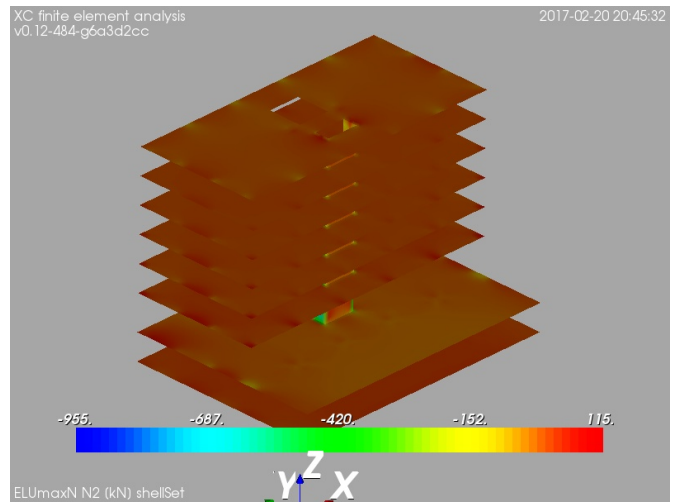

Figure 88: ELUmaxN: maximum internal force N. Shell elements, internal axial force in local direction 2 [kN]

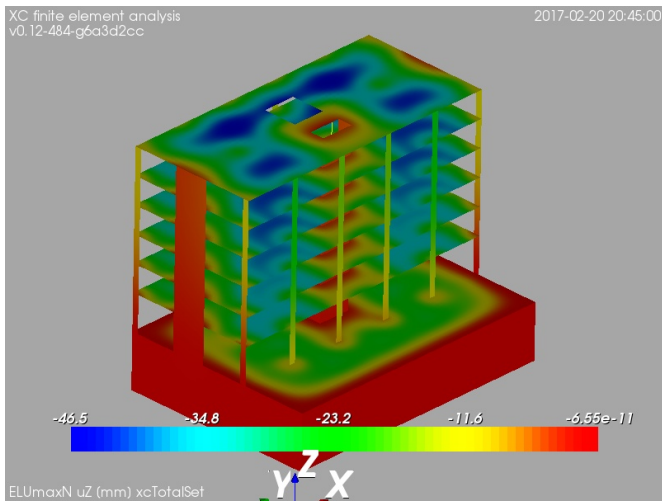

Figure 86: ELUmaxN: maximum internal force N. Overall set, displacement in global Z direction [mm]

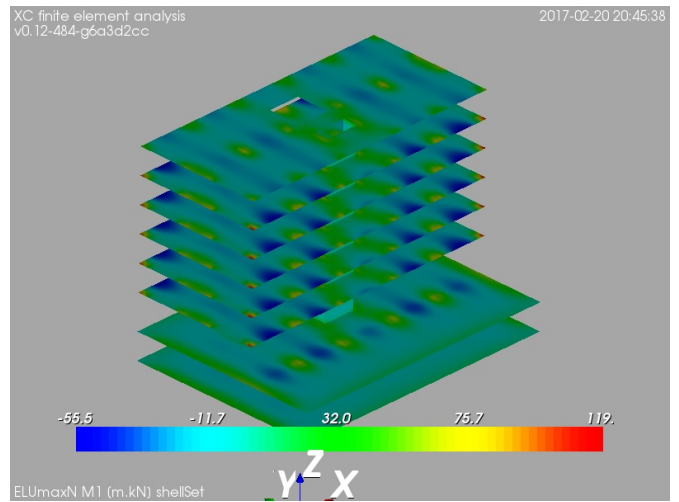

Figure 89: ELUmaxN: maximum internal force N. Shell elements, bending moment around local axis 1 [m.kN]

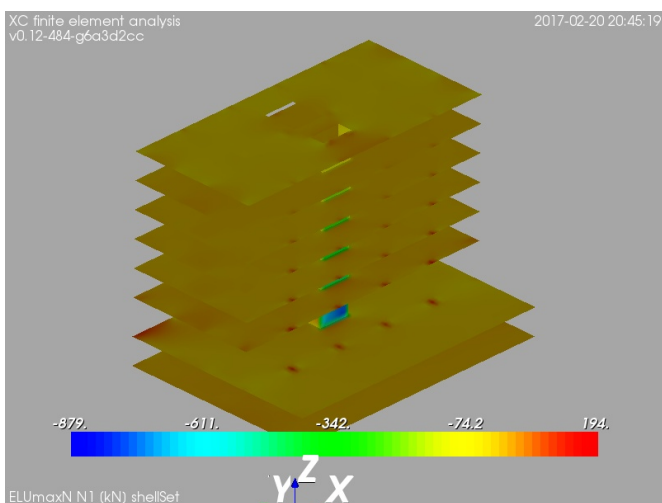

Figure 87: ELUmaxN: maximum internal force N. Shell elements, internal axial force in local direction 1 [kN]

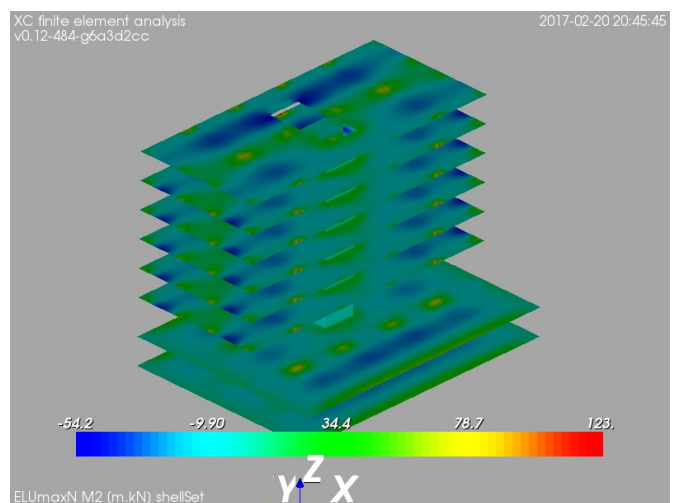

Figure 90: ELUmaxN: maximum internal force N. Shell elements, bending moment around local axis 2 [m.kN]

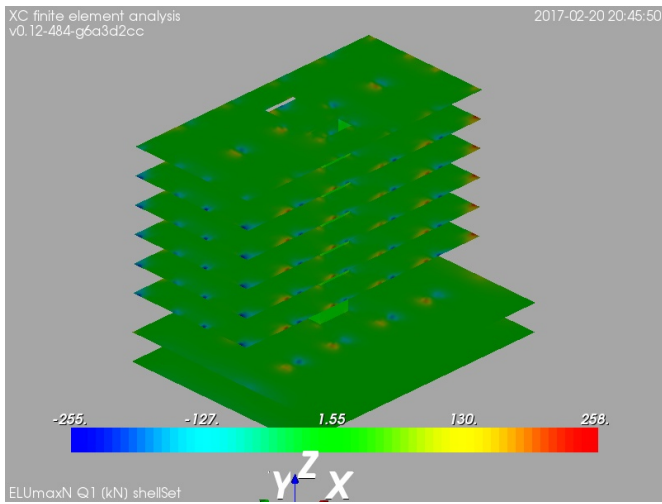

Figure 91: ELUmaxN: maximum internal force N. Shell elements, internal shear force in local direction 1 [kN]

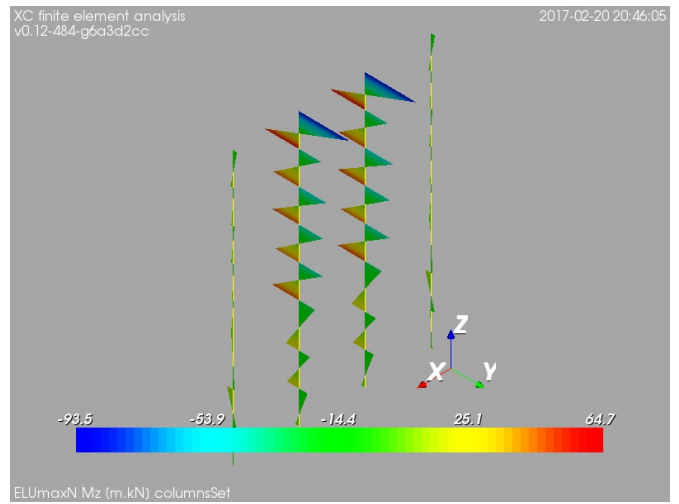

Figure 94: ELUmaxN: maximum internal force N. Inner columns, bending moment around local axis z [m.kN]

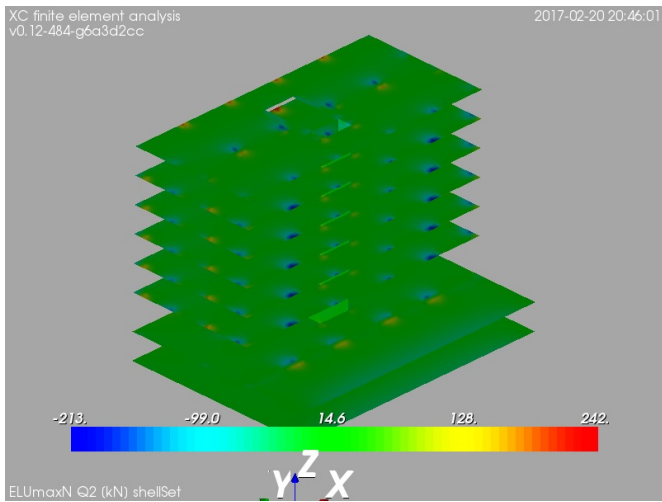

Figure 92: ELUmaxN: maximum internal force N. Shell elements, internal shear force in local direction 2 [kN]

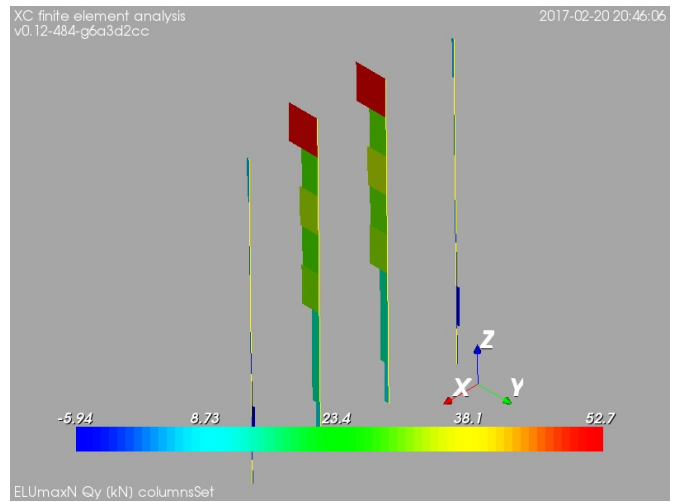

Figure 95: ELUmaxN: maximum internal force N. Inner columns, internal shear force in local direction y [kN]

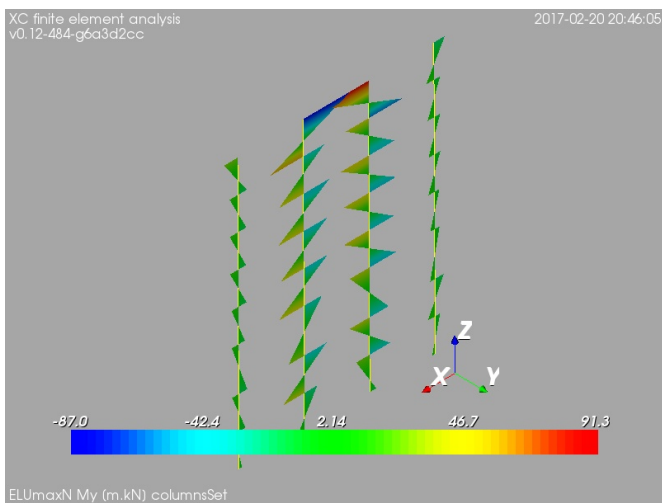

Figure 93: ELUmaxN: maximum internal force N. Inner columns, bending moment around local axis y [m.kN]

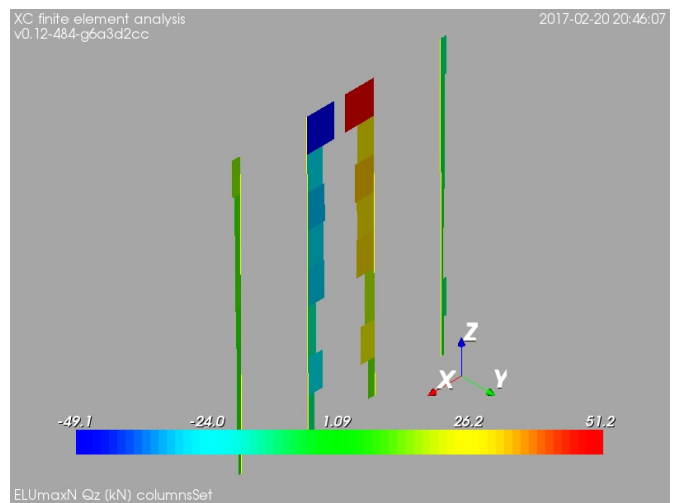

Figure 96: ELUmaxN: maximum internal force N. Inner columns, internal shear force in local direction z [kN]

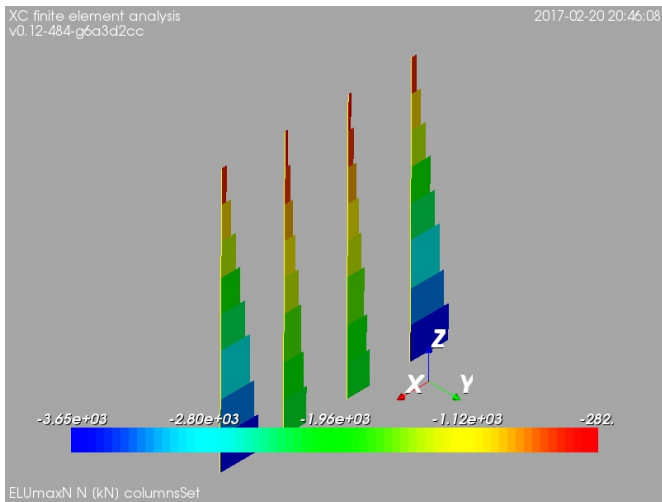

Figure 97: ELUmaxN: maximum internal force N. Inner columns, internal axial force [kN]

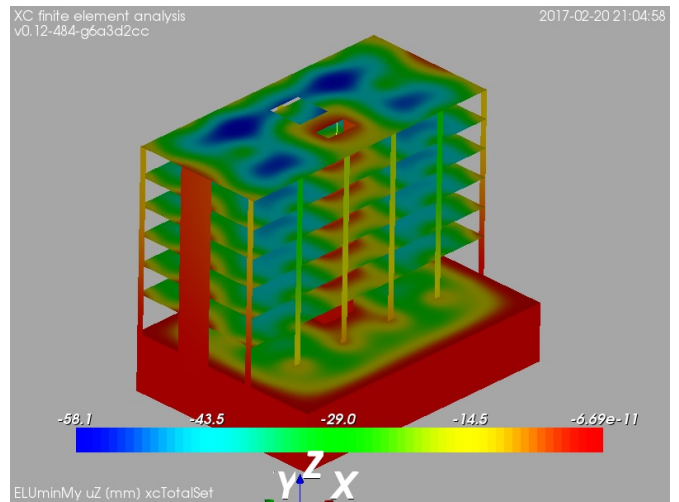

Figure 100: ELUminMy: minimum internal moment My. Overall set, displacement in global Z direction [mm]

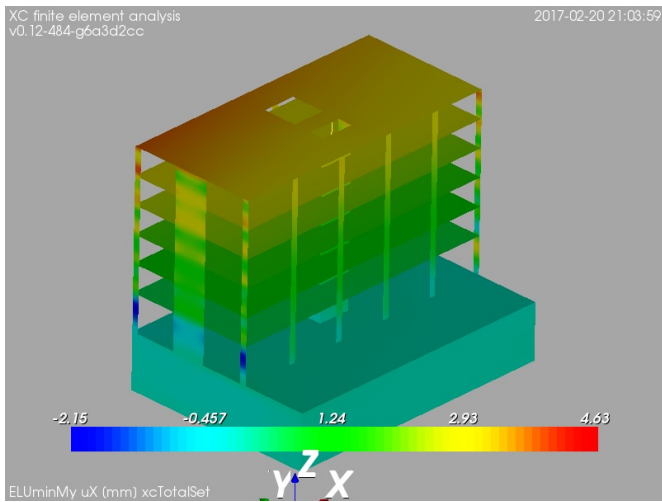

Figure 98: ELUminMy: minimum internal moment My. Overall set, displacement in global X direction [mm]

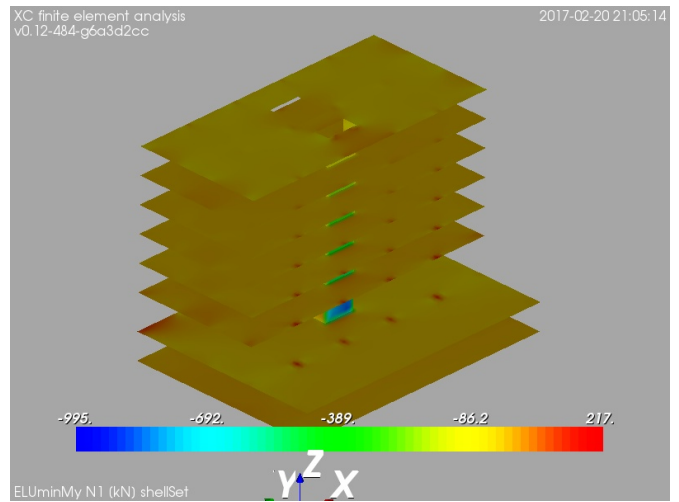

Figure 101: ELUminMy: minimum internal moment My. Shell elements, internal axial force in local direction 1 [kN]

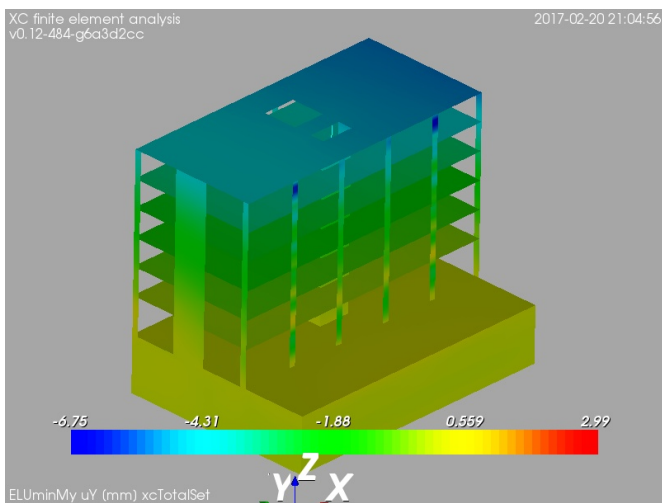

Figure 99: ELUminMy: minimum internal moment My. Overall set, displacement in global Y direction [mm]

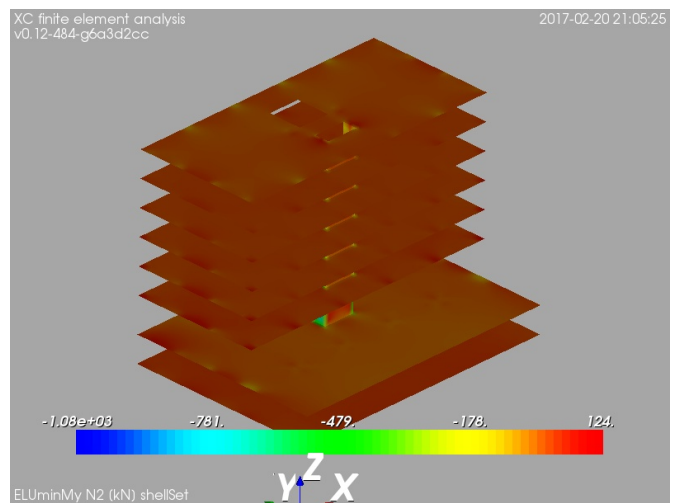

Figure 102: ELUminMy: minimum internal moment My. Shell elements, internal axial force in local direction 2 [kN]

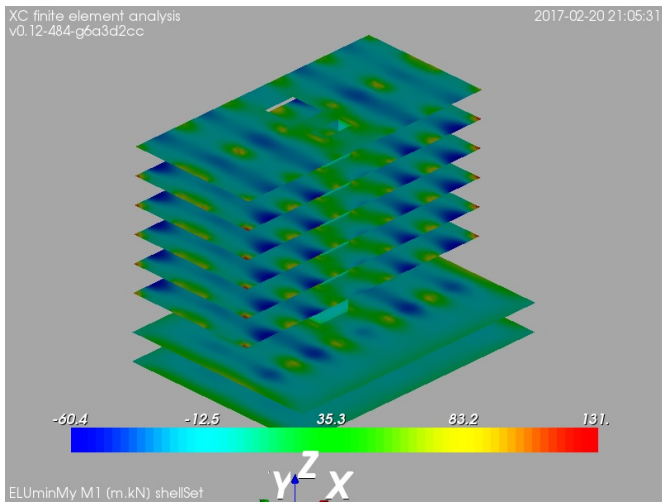

Figure 103: ELUminMy: minimum internal moment My. Shell elements, bending moment around local axis 1 [m.kN]

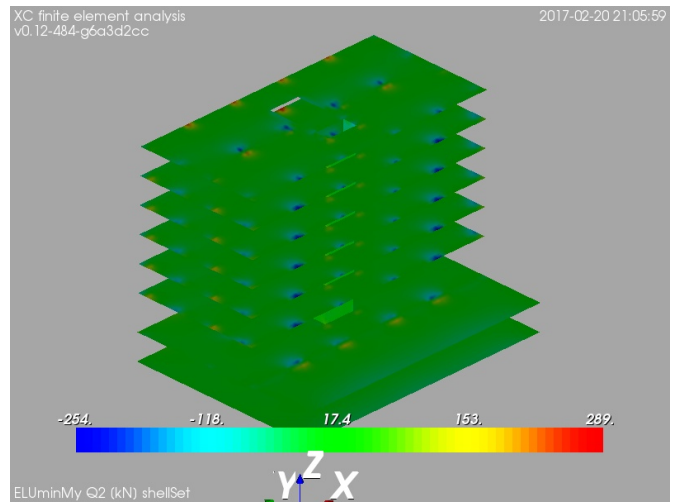

Figure 106: ELUminMy: minimum internal moment My. Shell elements, internal shear force in local direction 2 [kN]

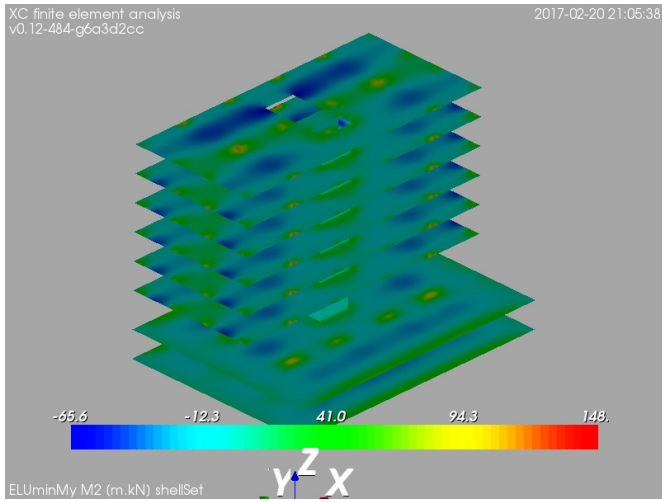

Figure 104: ELUminMy: minimum internal moment My. Shell elements, bending moment around local axis 2 [m.kN]

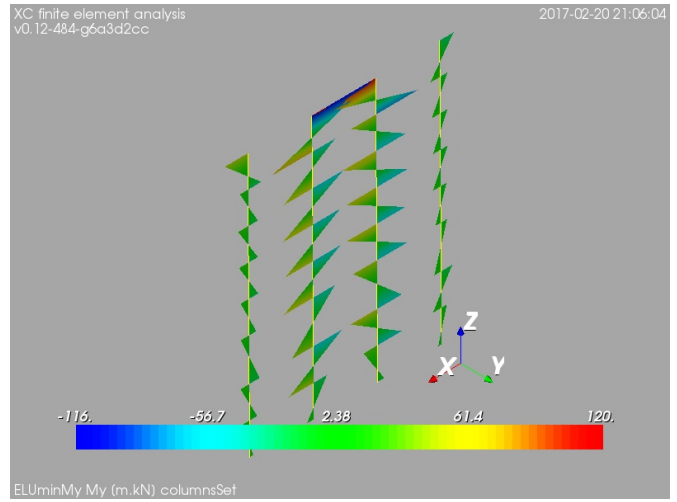

Figure 107: ELUminMy: minimum internal moment My. Inner columns, bending moment around local axis y [m.kN]

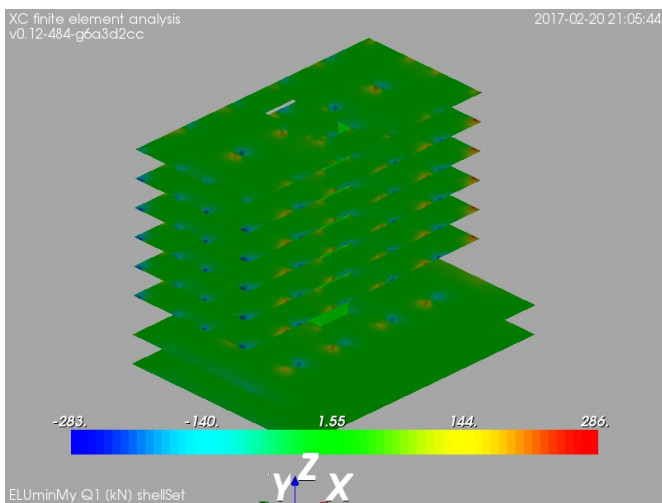

Figure 105: ELUminMy: minimum internal moment My. Shell elements, internal shear force in local direction 1 [kN]

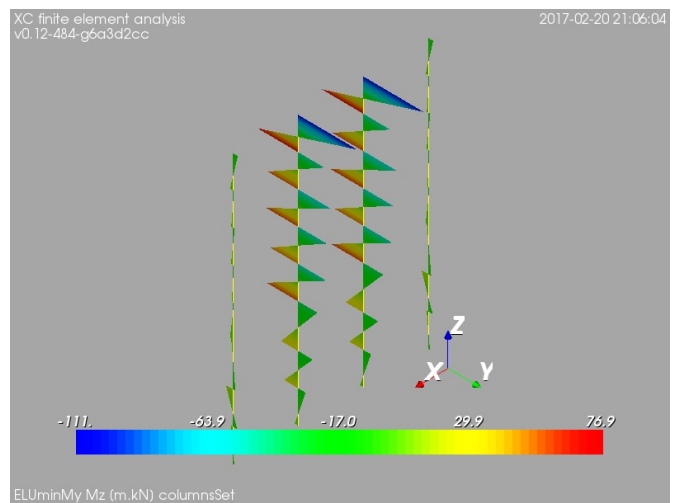

Figure 108: ELUminMy: minimum internal moment My. Inner columns, bending moment around local axis z [m.kN]

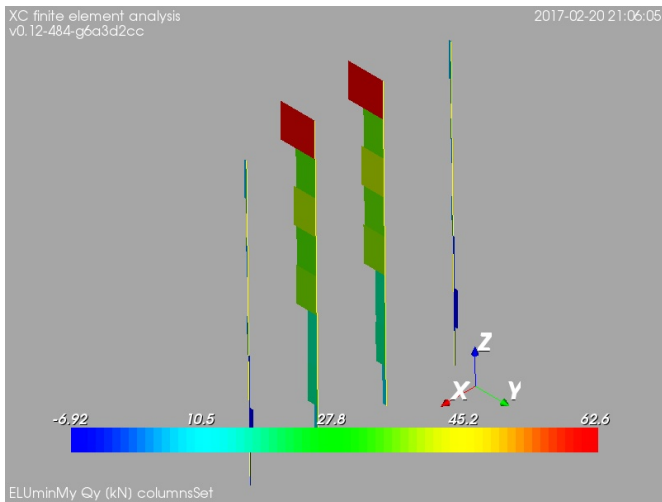

Figure 109: ELUminMy: minimum internal moment M_y . Inner columns, internal shear force in local direction y [kN]

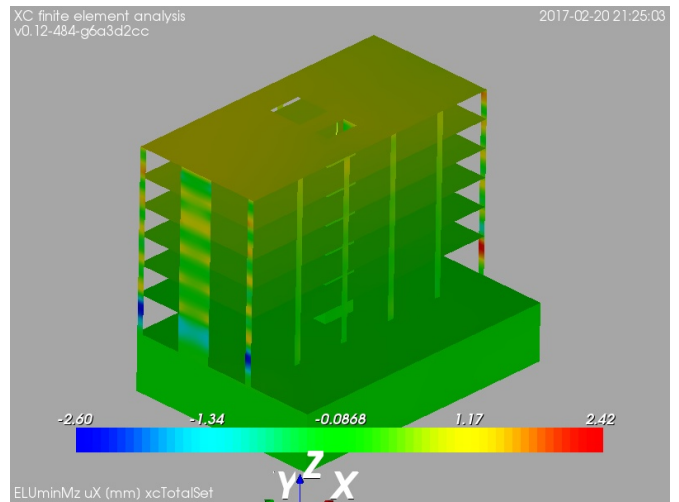

Figure 112: ELUminMz: minimum internal moment M_z . Overall set, displacement in global X direction [mm]

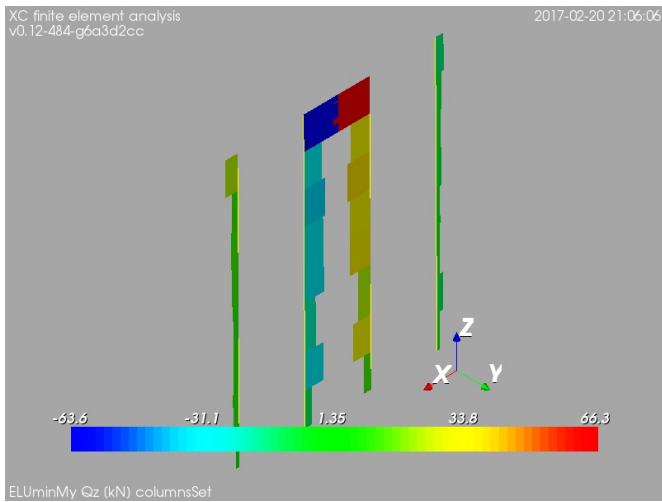

Figure 110: ELUminMy: minimum internal moment M_y . Inner columns, internal shear force in local direction z [kN]

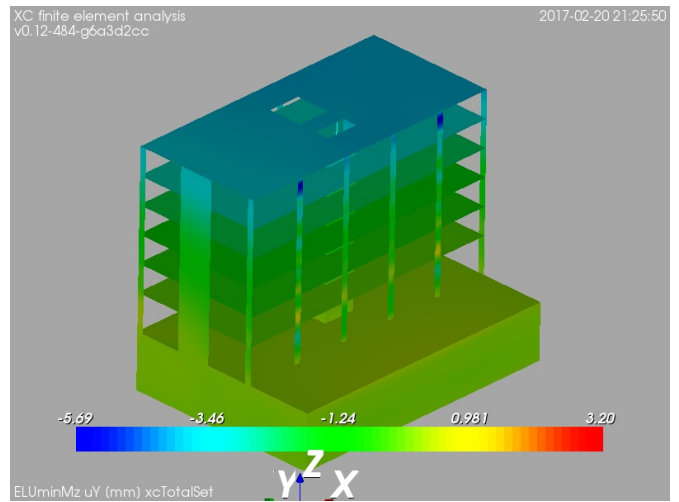

Figure 113: ELUminMz: minimum internal moment M_z . Overall set, displacement in global Y direction [mm]

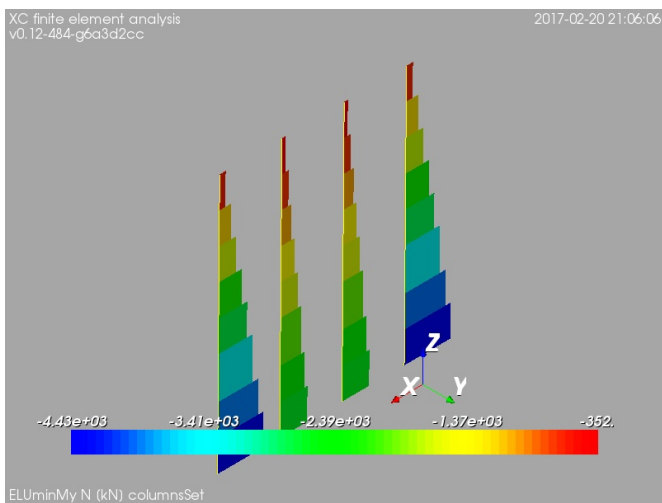

Figure 111: ELUminMy: minimum internal moment M_y . Inner columns, internal axial force [kN]

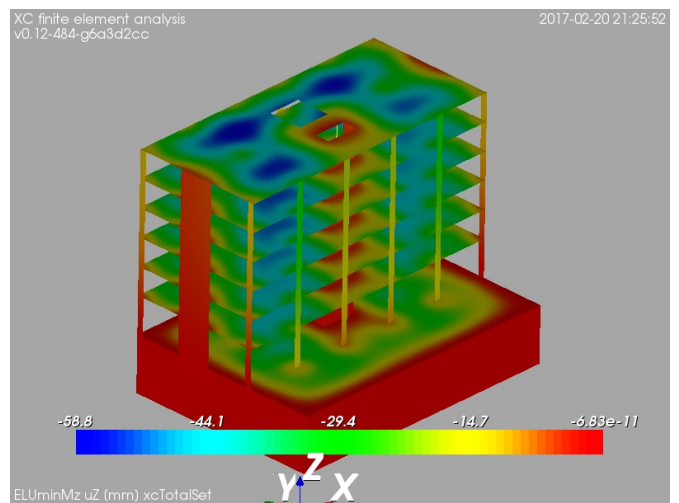

Figure 114: ELUminMz: minimum internal moment M_z . Overall set, displacement in global Z direction [mm]

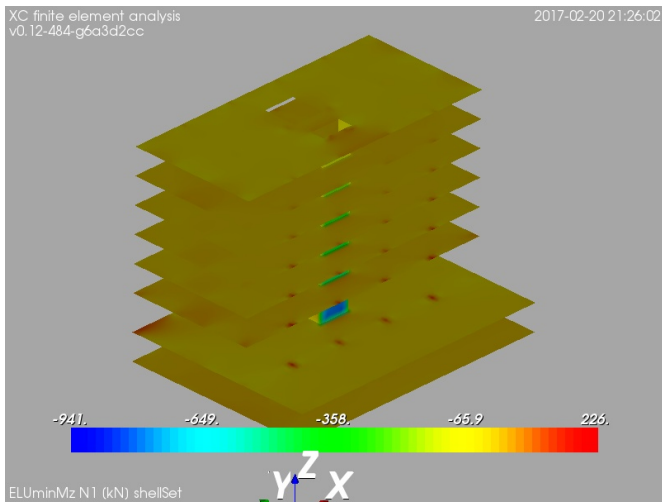

Figure 115: ELUminMz: minimum internal moment Mz. Shell elements, internal axial force in local direction 1 [kN]

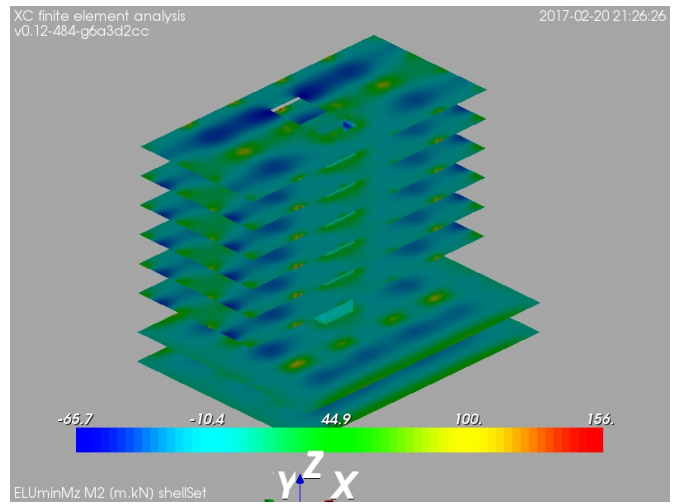

Figure 118: ELUminMz: minimum internal moment Mz. Shell elements, bending moment around local axis 2 [m.kN]

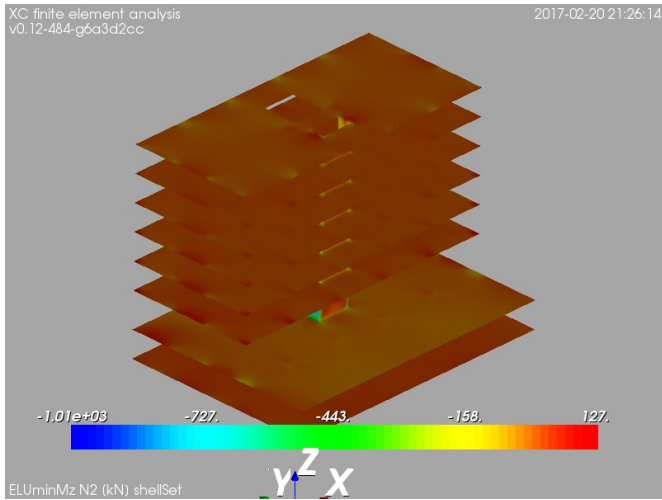

Figure 116: ELUminMz: minimum internal moment Mz. Shell elements, internal axial force in local direction 2 [kN]

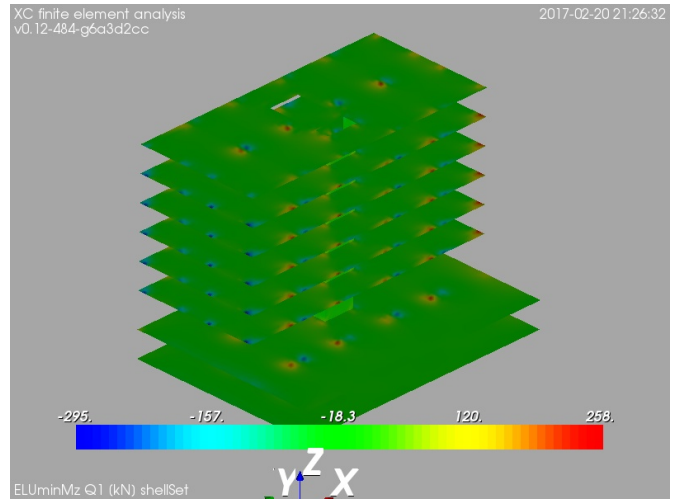

Figure 119: ELUminMz: minimum internal moment Mz. Shell elements, internal shear force in local direction 1 [kN]

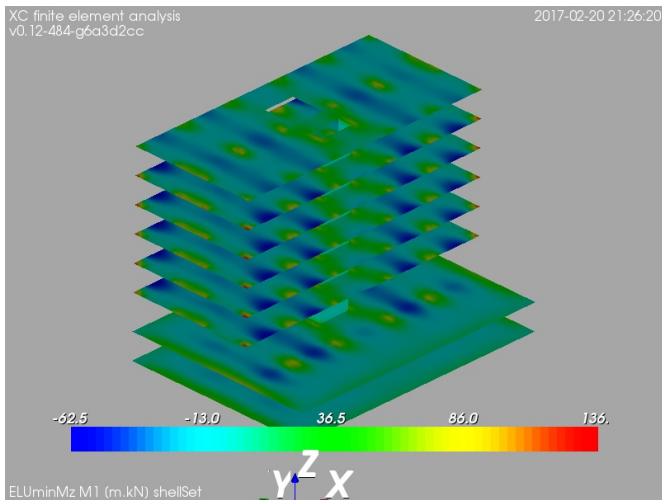

Figure 117: ELUminMz: minimum internal moment Mz. Shell elements, bending moment around local axis 1 [m.kN]

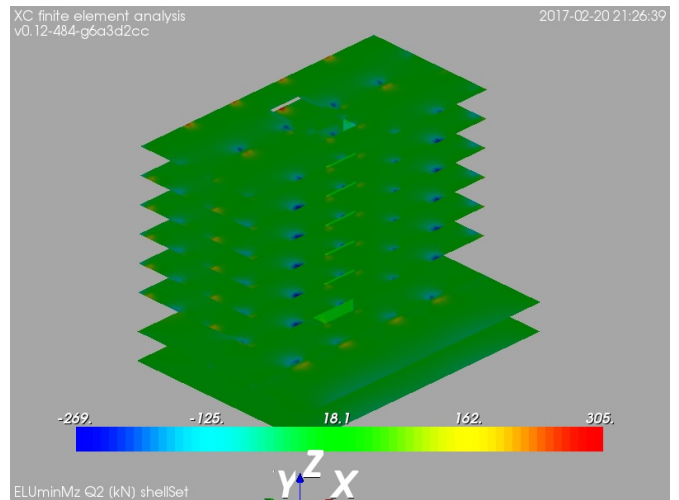

Figure 120: ELUminMz: minimum internal moment Mz. Shell elements, internal shear force in local direction 2 [kN]

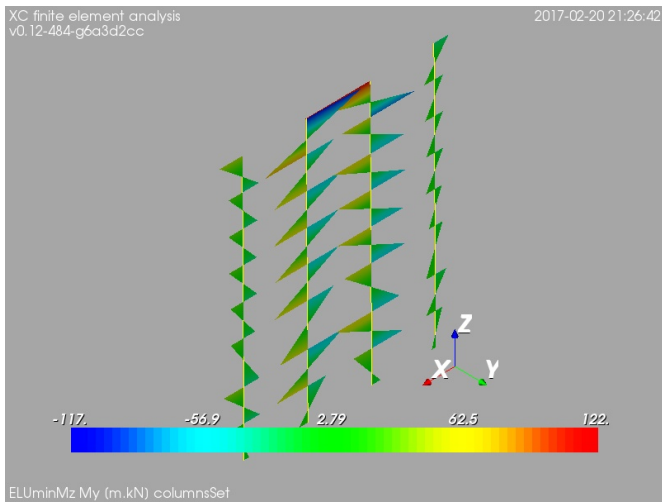

Figure 121: ELUminMz: minimum internal moment M_z . Inner columns, bending moment around local axis y [m.kN]

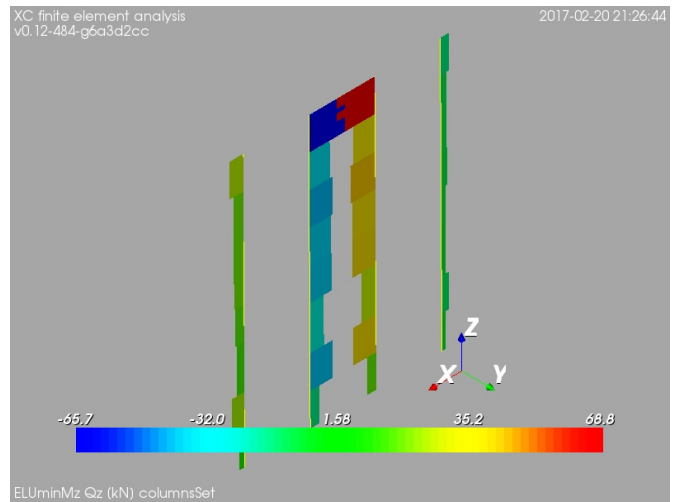

Figure 124: ELUminMz: minimum internal moment M_z . Inner columns, internal shear force in local direction z [kN]

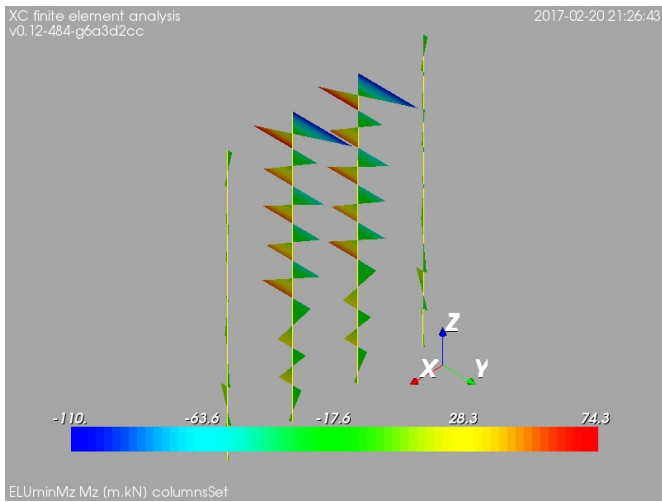

Figure 122: ELUminMz: minimum internal moment M_z . Inner columns, bending moment around local axis z [m.kN]

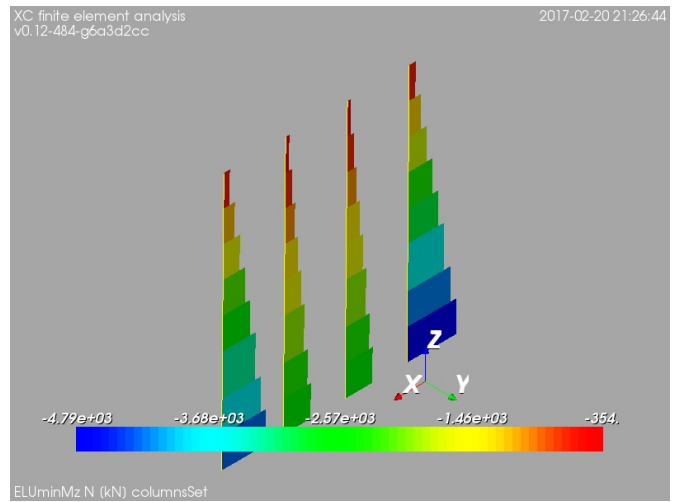

Figure 125: ELUminMz: minimum internal moment M_z . Inner columns, internal axial force [kN]

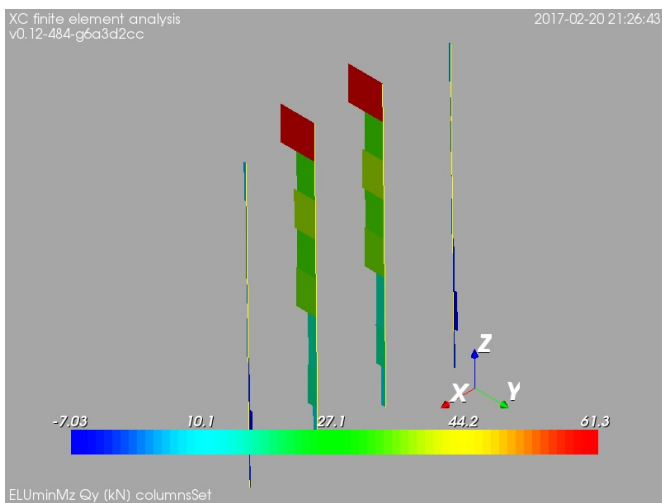

Figure 123: ELUminMz: minimum internal moment M_z . Inner columns, internal shear force in local direction y [kN]

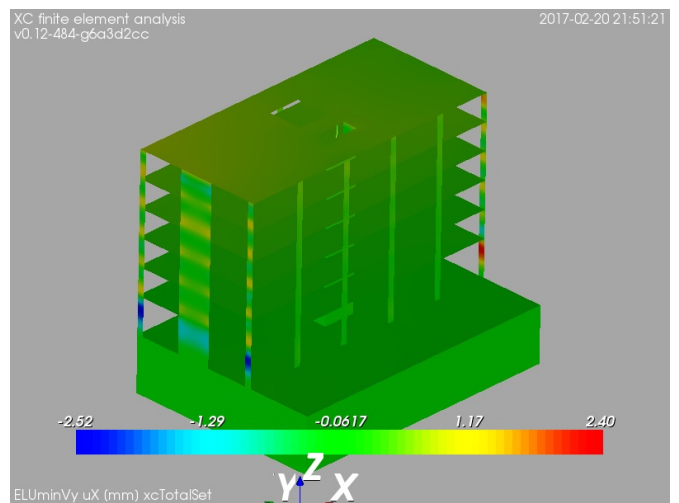

Figure 126: ELUminVy: minimum internal force V_y . Overall set, displacement in global X direction [mm]

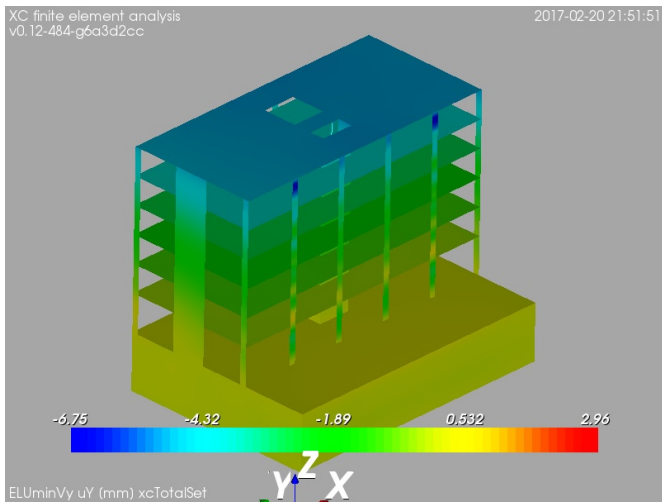

Figure 127: ELUminVy: minimum internal force V_y . Overall set, displacement in global Y direction [mm]

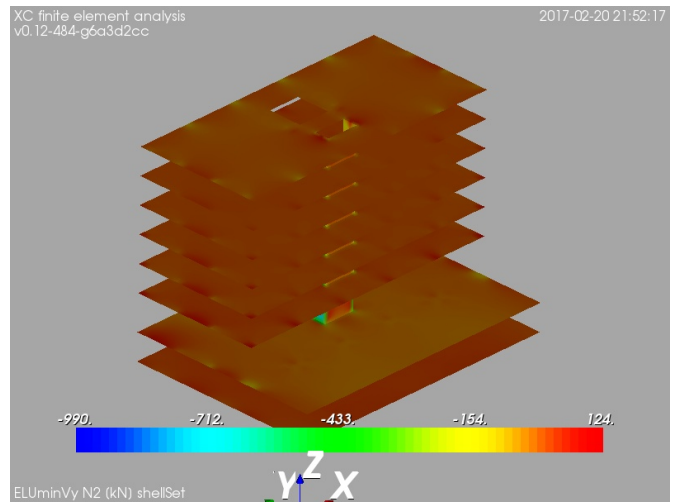

Figure 130: ELUminVy: minimum internal force V_y . Shell elements, internal axial force in local direction 2 [kN]

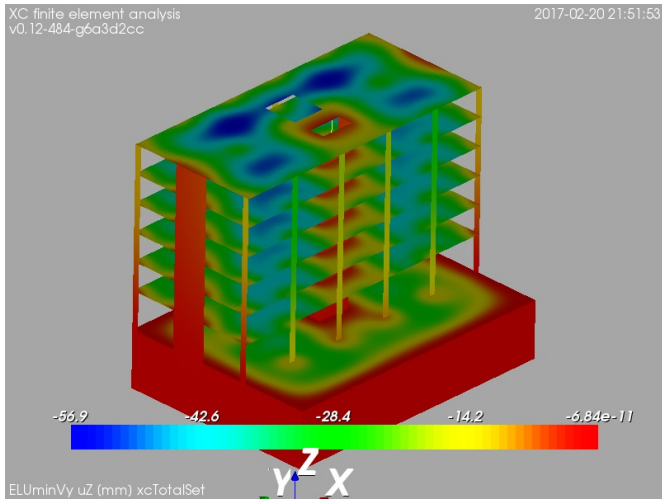

Figure 128: ELUminVy: minimum internal force V_y . Overall set, displacement in global Z direction [mm]

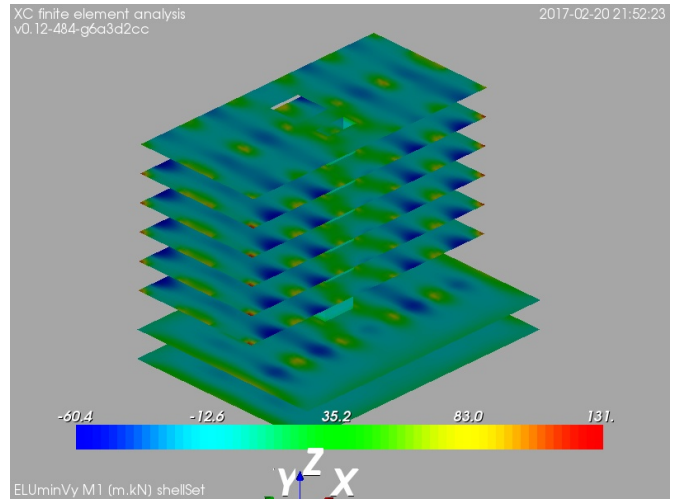

Figure 131: ELUminVy: minimum internal force V_y . Shell elements, bending moment around local axis 1 [m.kN]

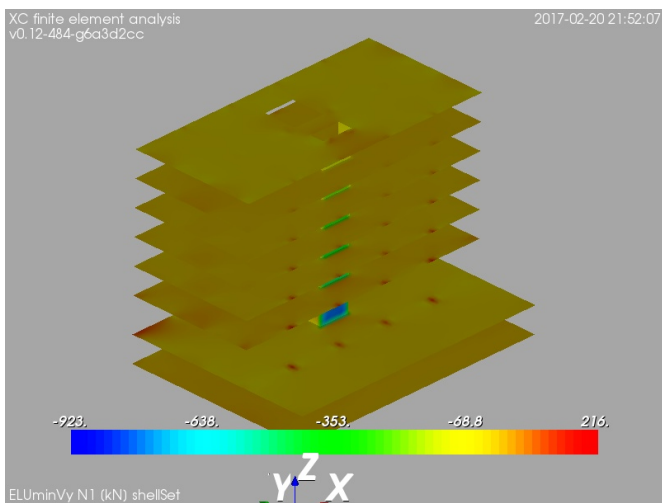

Figure 129: ELUminVy: minimum internal force V_y . Shell elements, internal axial force in local direction 1 [kN]

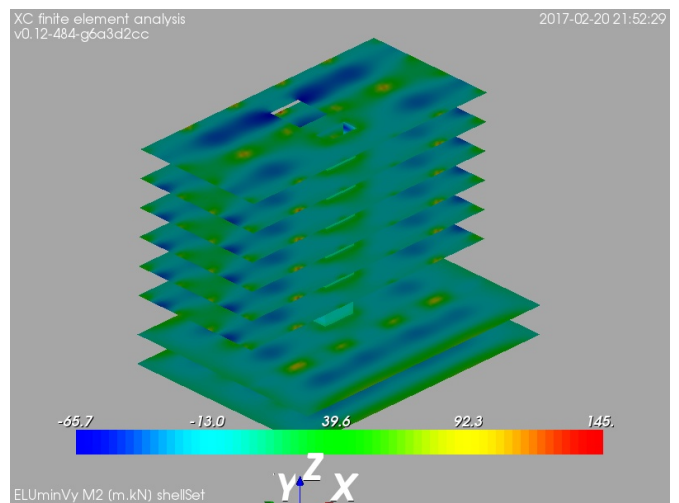

Figure 132: ELUminVy: minimum internal force V_y . Shell elements, bending moment around local axis 2 [m.kN]

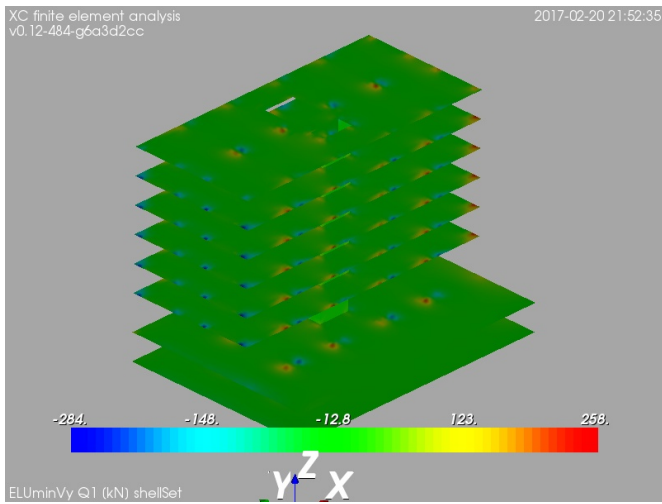

Figure 133: ELUminVy: minimum internal force Vy. Shell elements, internal shear force in local direction 1 [kN]

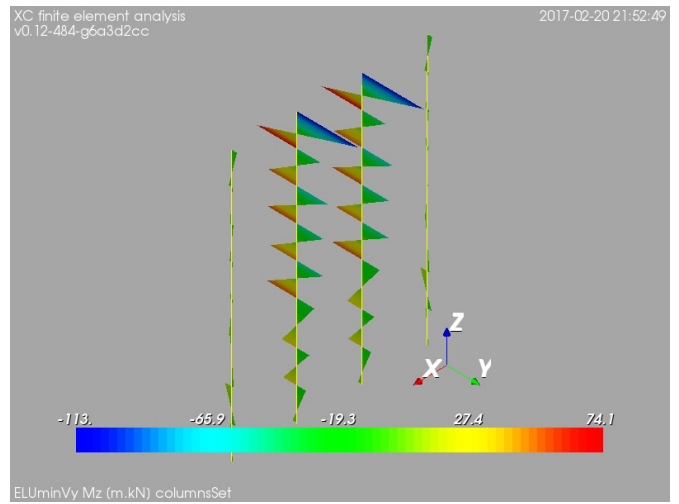

Figure 136: ELUminVy: minimum internal force Vy. Inner columns, bending moment around local axis z [m.kN]

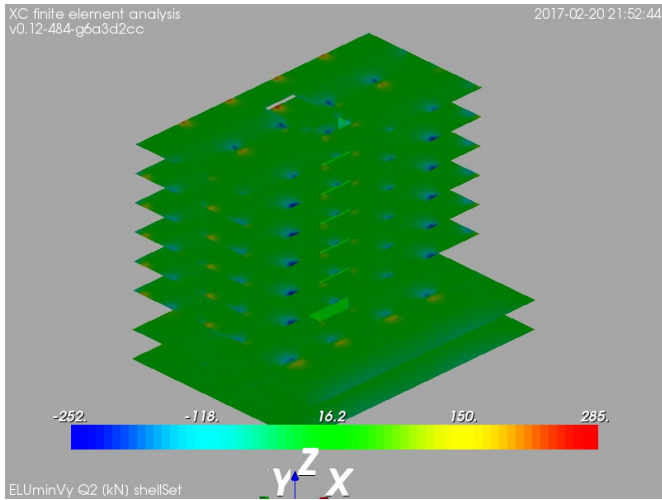

Figure 134: ELUminVy: minimum internal force Vy. Shell elements, internal shear force in local direction 2 [kN]

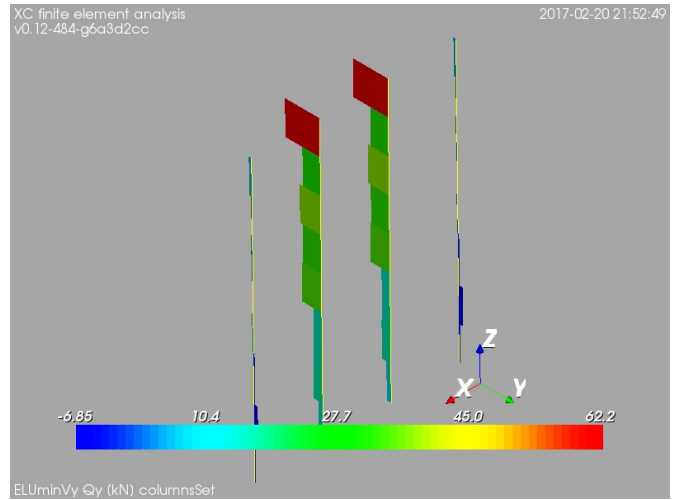

Figure 137: ELUminVy: minimum internal force Vy. Inner columns, internal shear force in local direction y [kN]

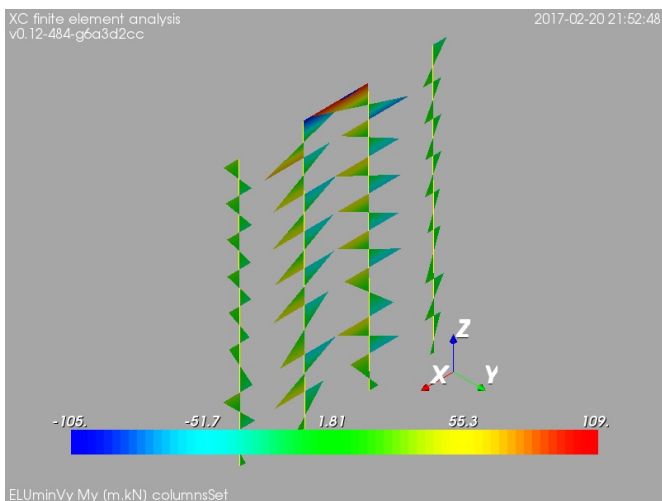

Figure 135: ELUminVy: minimum internal force Vy. Inner columns, bending moment around local axis y [m.kN]

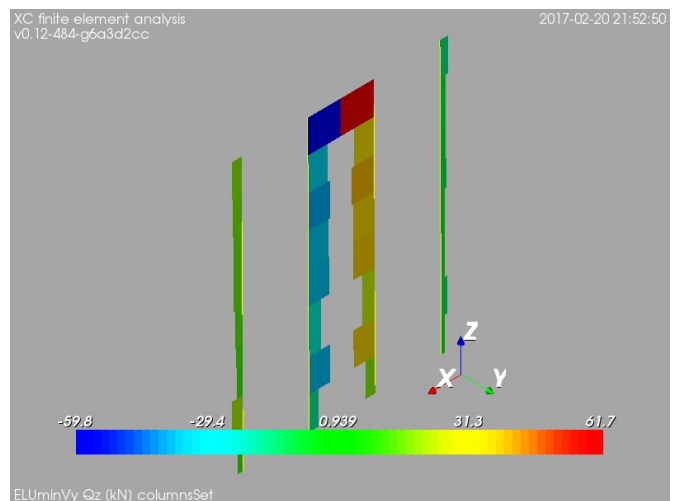

Figure 138: ELUminVy: minimum internal force Vy. Inner columns, internal shear force in local direction z [kN]

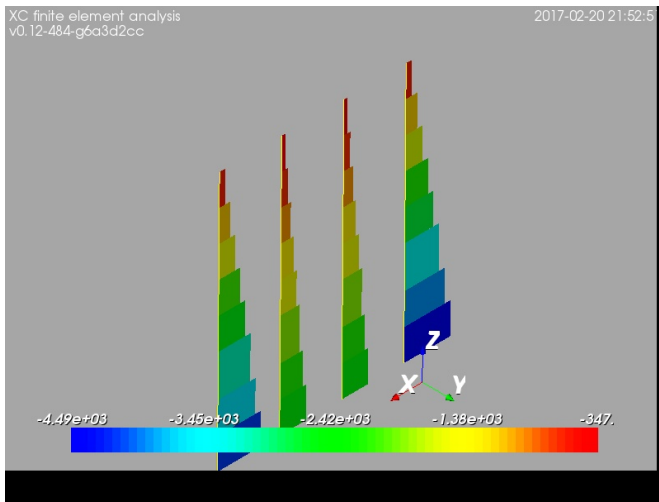

Figure 139: ELUminVy: minimum internal force Vy. Inner columns, internal axial force [kN]

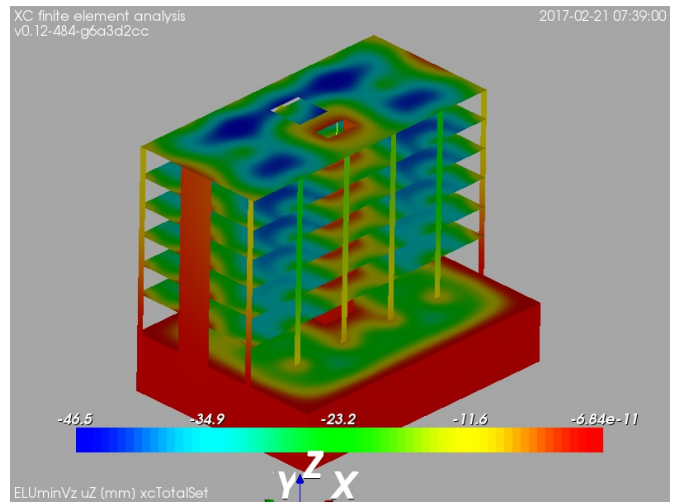

Figure 142: ELUminVz: minimum internal force Vz. Overall set, displacement in global Z direction [mm]

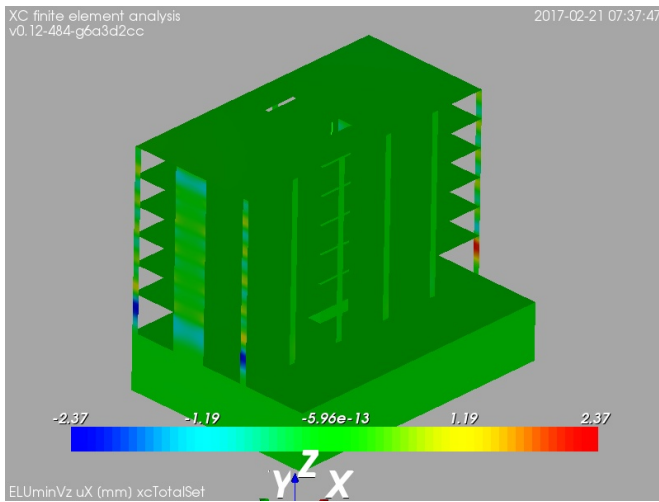

Figure 140: ELUminVz: minimum internal force Vz. Overall set, displacement in global X direction [mm]

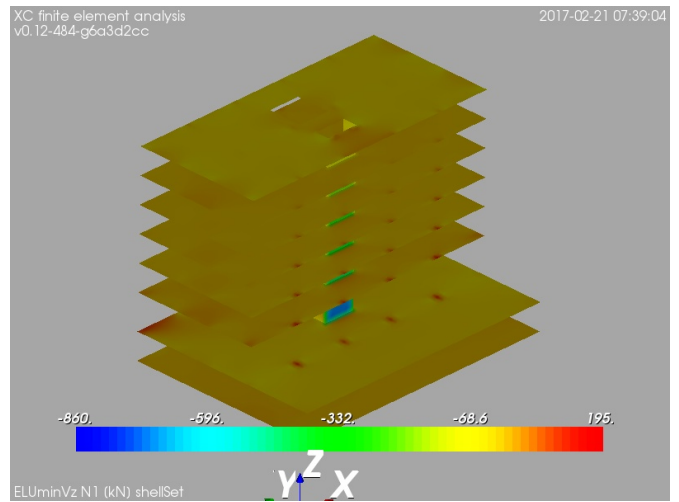

Figure 143: ELUminVz: minimum internal force Vz. Shell elements, internal axial force in local direction 1 [kN]

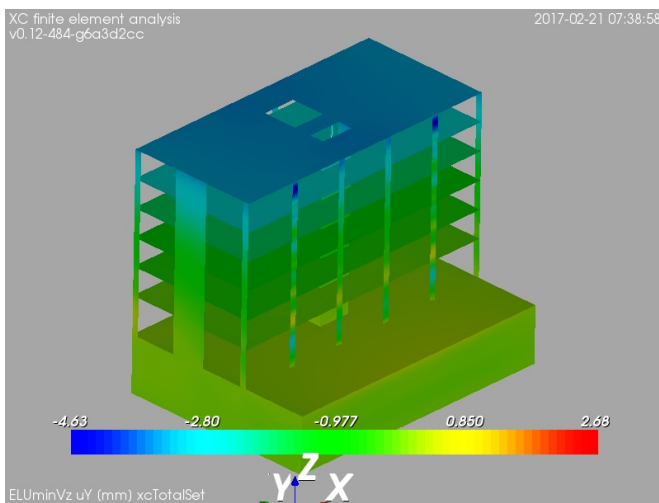

Figure 141: ELUminVz: minimum internal force Vz. Overall set, displacement in global Y direction [mm]

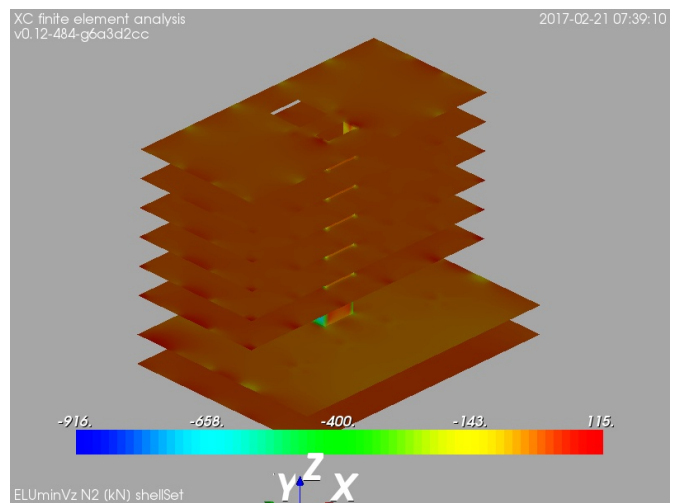

Figure 144: ELUminVz: minimum internal force Vz. Shell elements, internal axial force in local direction 2 [kN]

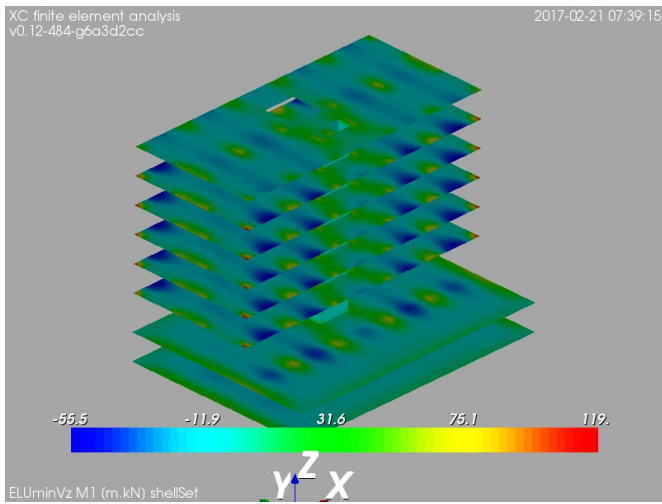

Figure 145: ELUminVz: minimum internal force Vz. Shell elements, bending moment around local axis 1 [m.kN]

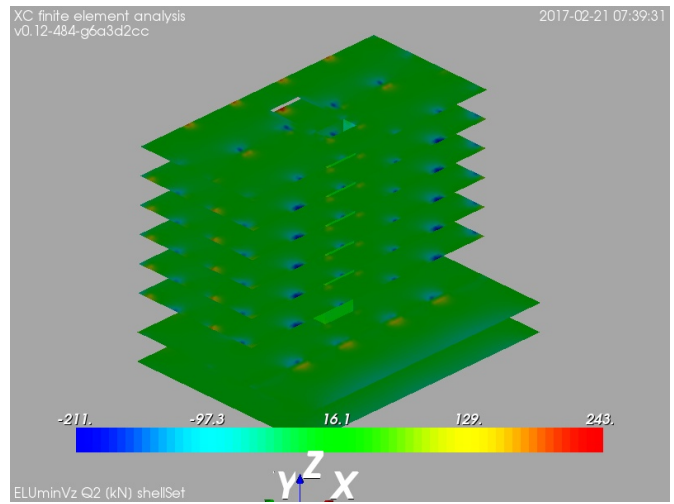

Figure 148: ELUminVz: minimum internal force Vz. Shell elements, internal shear force in local direction 2 [kN]

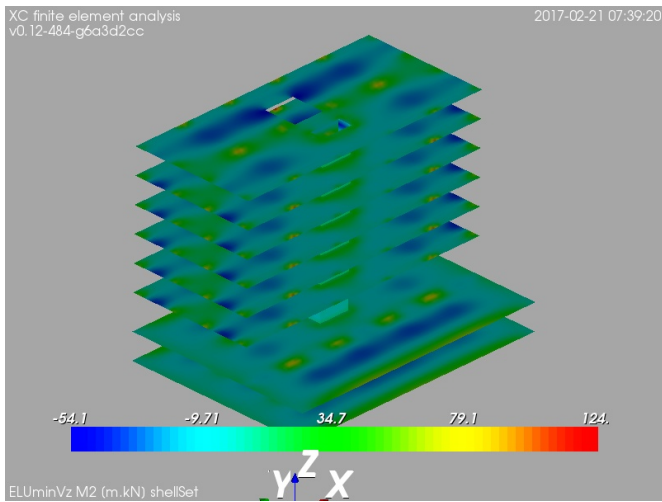

Figure 146: ELUminVz: minimum internal force Vz. Shell elements, bending moment around local axis 2 [m.kN]

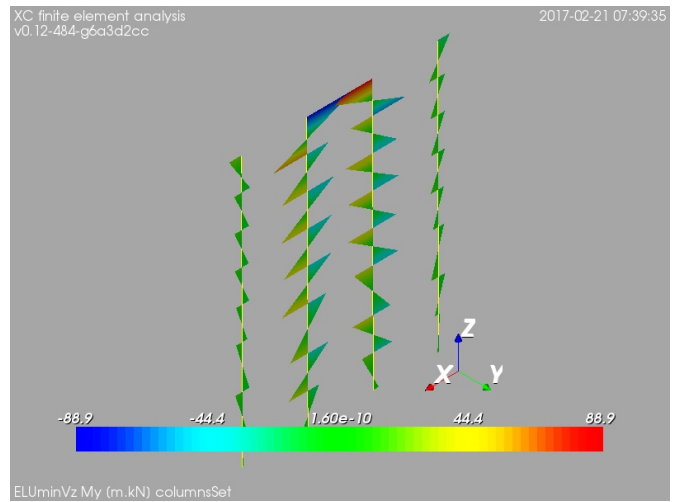

Figure 149: ELUminVz: minimum internal force Vz. Inner columns, bending moment around local axis y [m.kN]

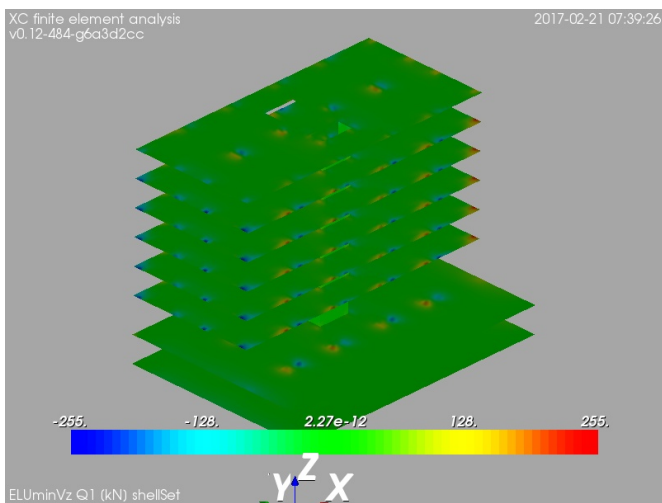

Figure 147: ELUminVz: minimum internal force Vz. Shell elements, internal shear force in local direction 1 [kN]

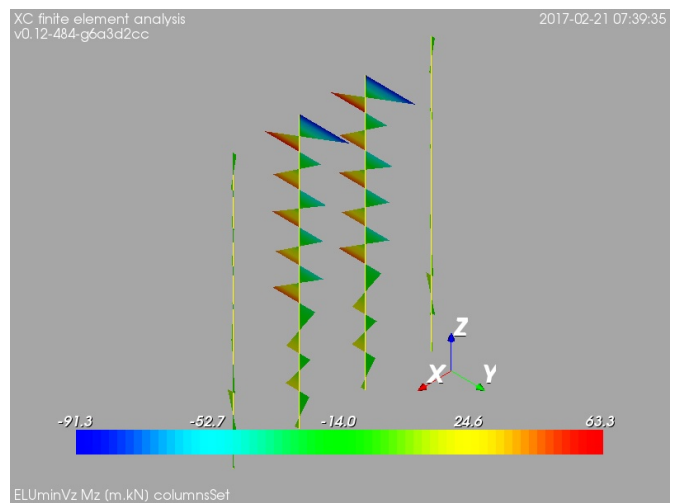

Figure 150: ELUminVz: minimum internal force Vz. Inner columns, bending moment around local axis z [m.kN]

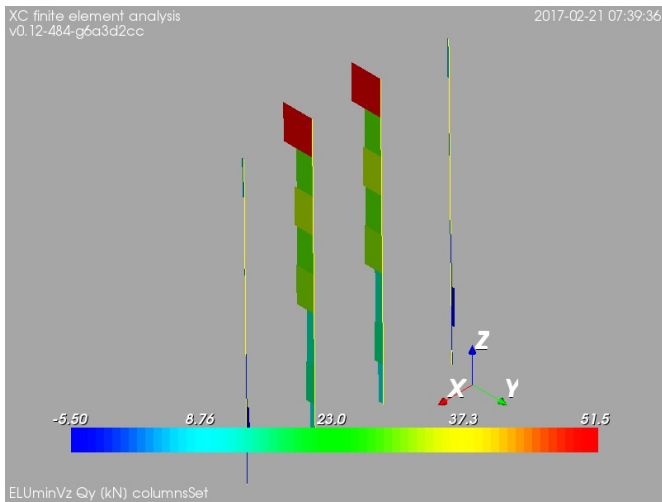

Figure 151: ELUminVz: minimum internal force Vz. Inner columns, internal shear force in local direction y [kN]

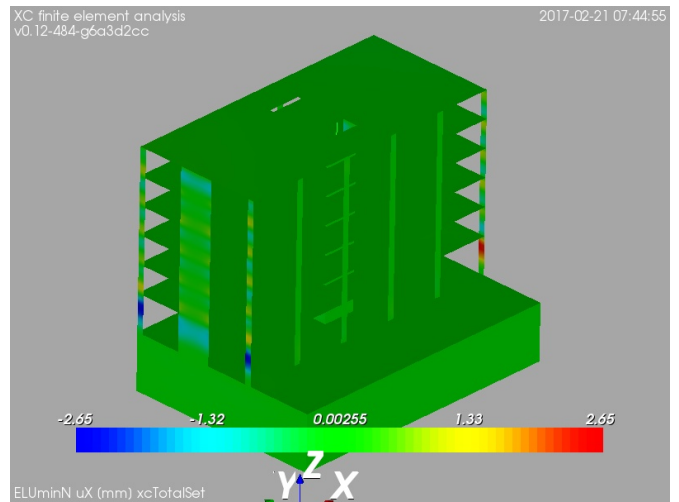

Figure 154: ELUminN: minimum internal force N. Overall set, displacement in global X direction [mm]

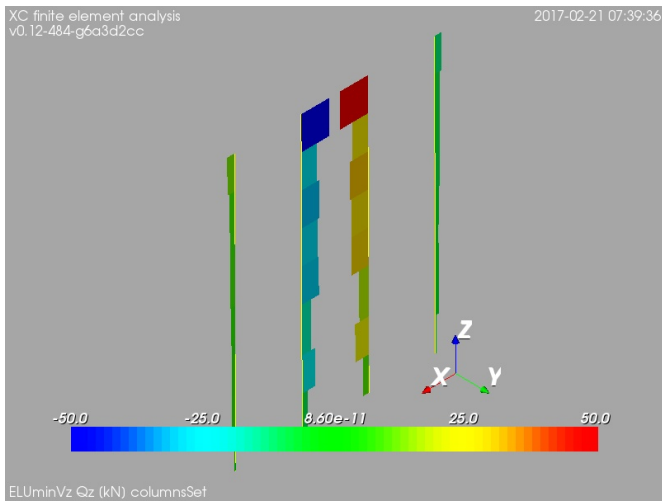

Figure 152: ELUminVz: minimum internal force Vz. Inner columns, internal shear force in local direction z [kN]

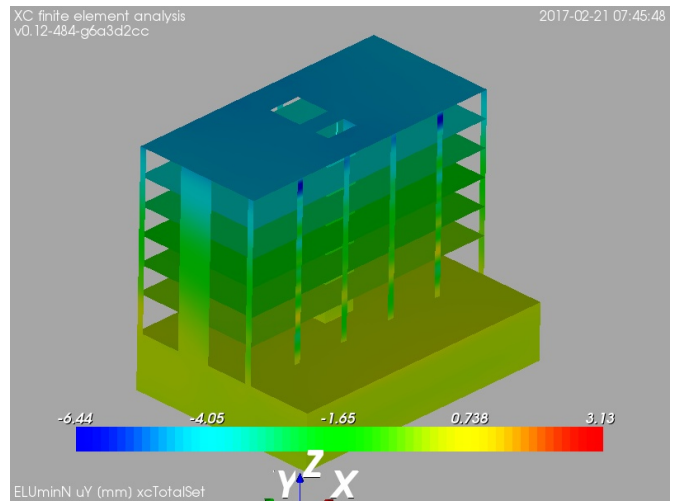

Figure 155: ELUminN: minimum internal force N. Overall set, displacement in global Y direction [mm]

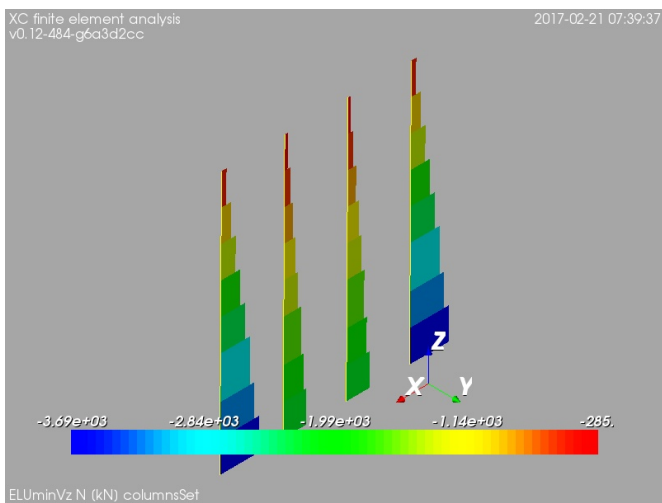

Figure 153: ELUminVz: minimum internal force Vz. Inner columns, internal axial force [kN]

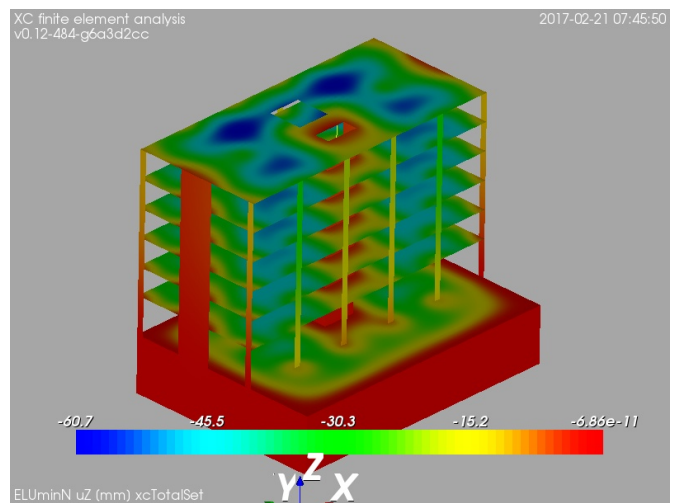

Figure 156: ELUminN: minimum internal force N. Overall set, displacement in global Z direction [mm]

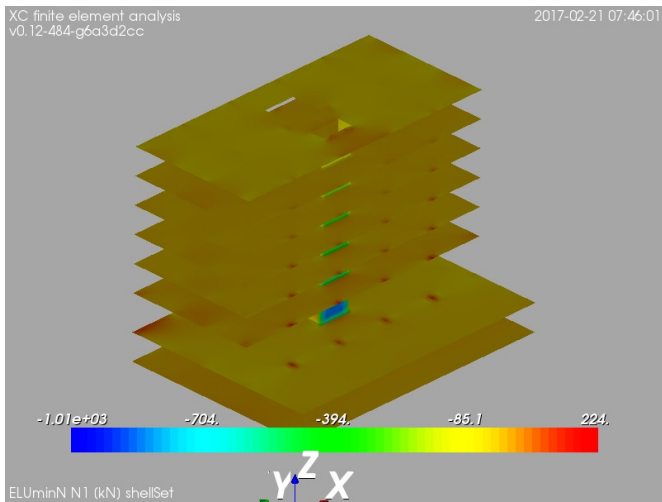

Figure 157: ELUminN: minimum internal force N. Shell elements, internal axial force in local direction 1 [kN]

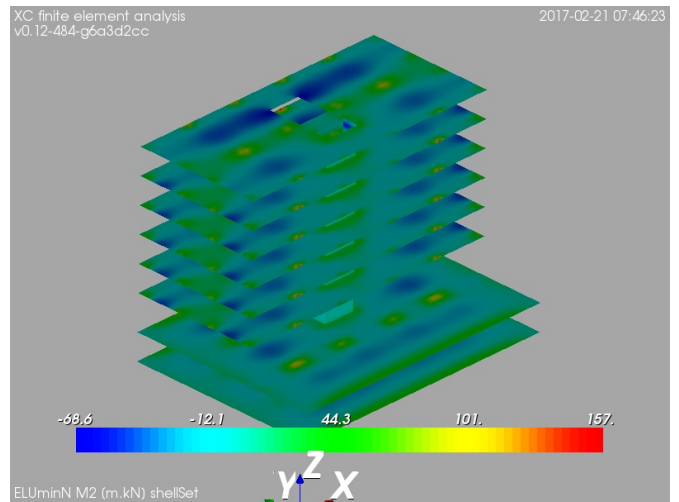

Figure 160: ELUminN: minimum internal force N. Shell elements, bending moment around local axis 2 [m.kN]

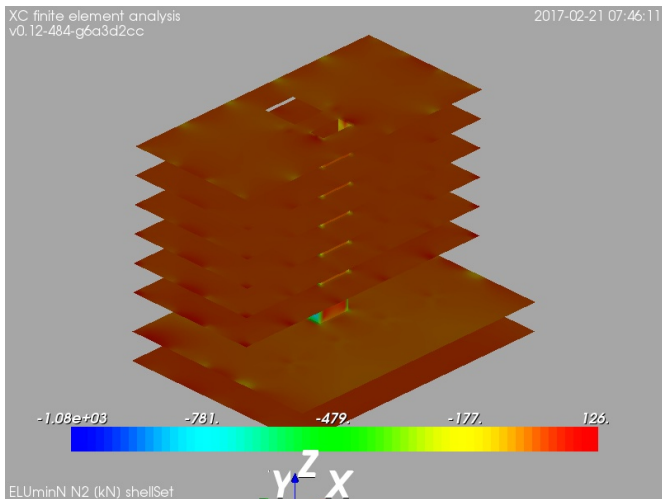

Figure 158: ELUminN: minimum internal force N. Shell elements, internal axial force in local direction 2 [kN]

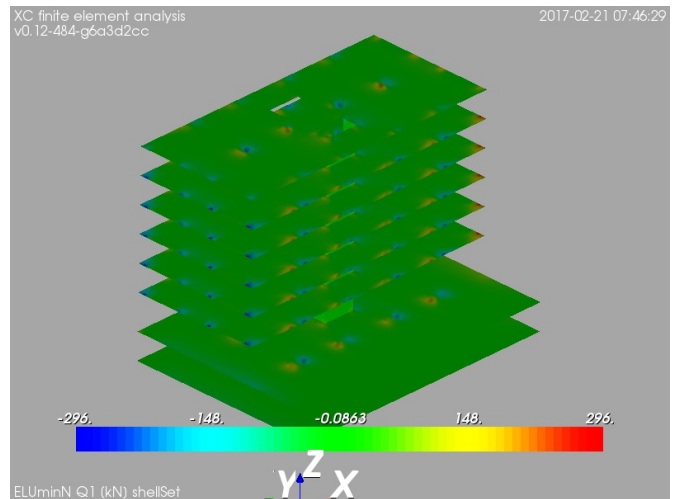

Figure 161: ELUminN: minimum internal force N. Shell elements, internal shear force in local direction 1 [kN]

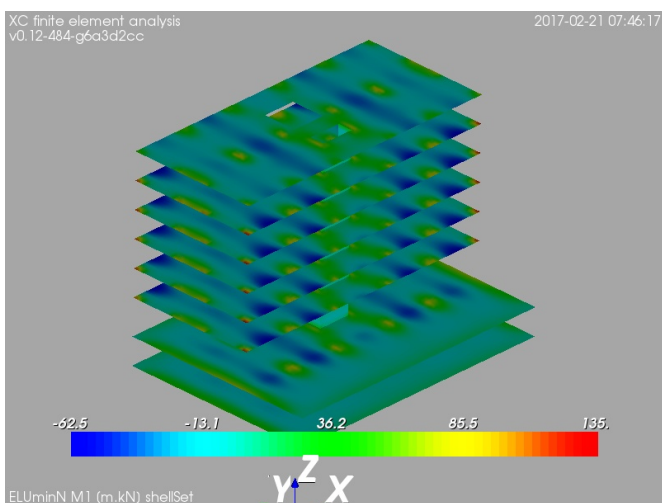

Figure 159: ELUminN: minimum internal force N. Shell elements, bending moment around local axis 1 [m.kN]

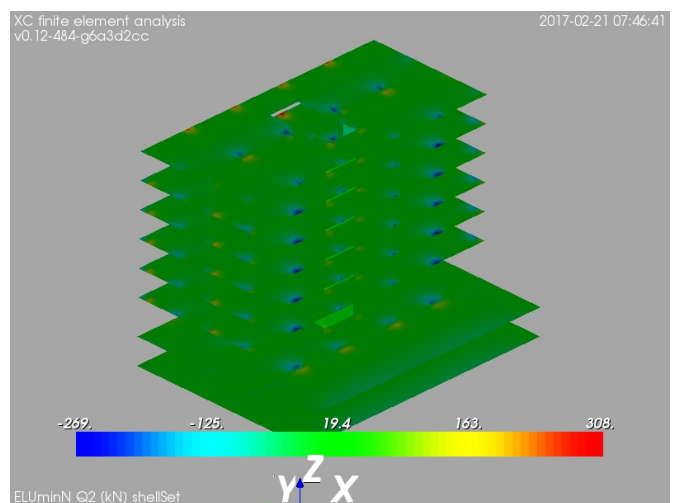

Figure 162: ELUminN: minimum internal force N. Shell elements, internal shear force in local direction 2 [kN]

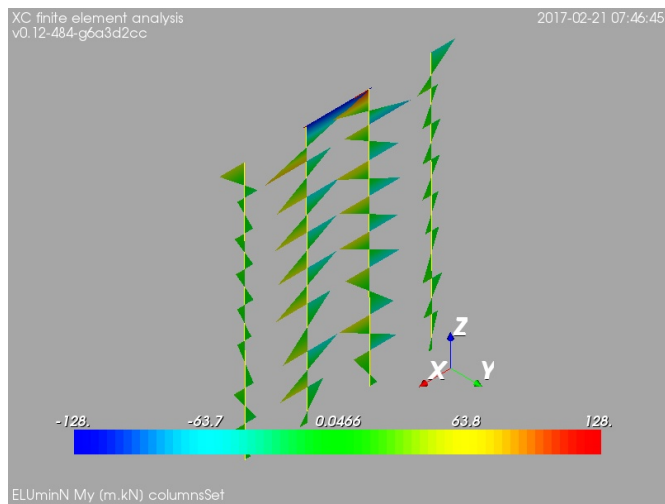

Figure 163: ELUminN: minimum internal force N. Inner columns, bending moment around local axis y [m.kN]

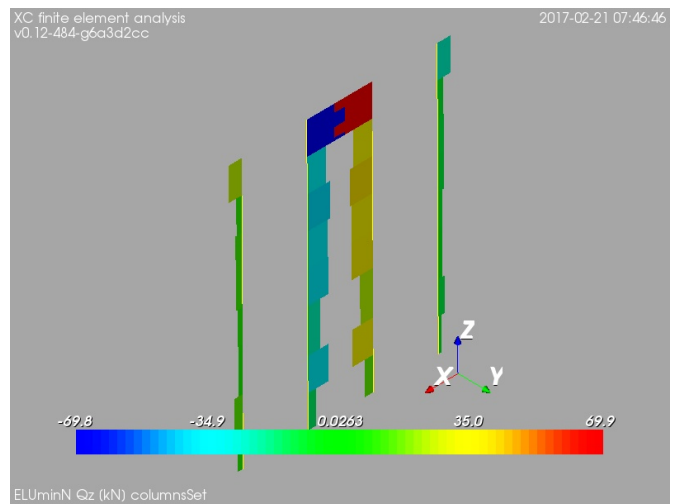

Figure 165: ELUminN: minimum internal force N. Inner columns, internal shear force in local direction z [kN]

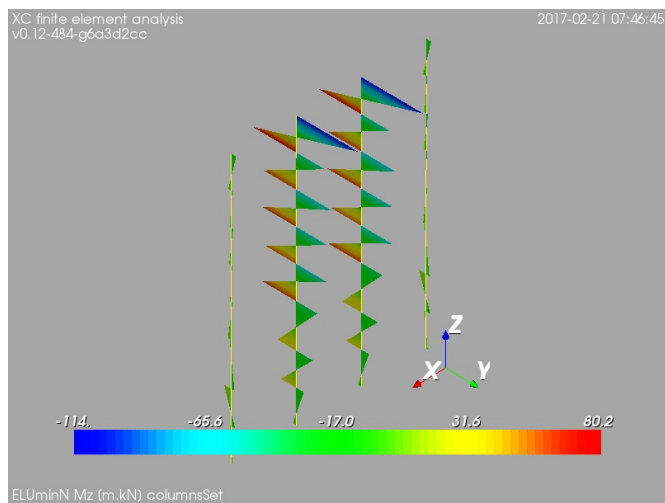

Figure 164: ELUminN: minimum internal force N. Inner columns, bending moment around local axis z [m.kN]

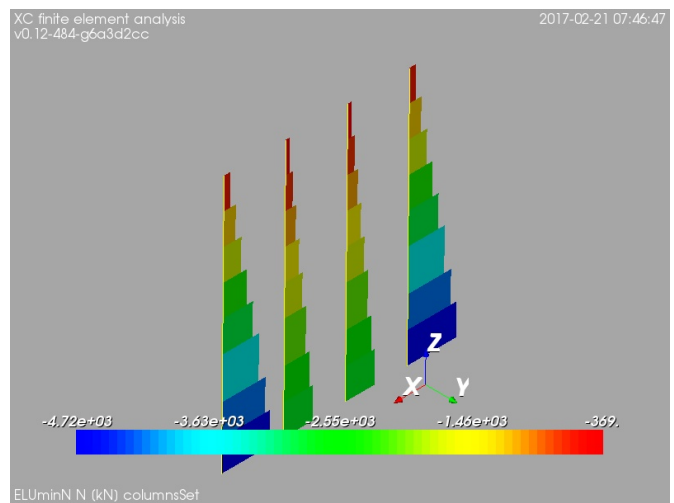

Figure 166: ELUminN: minimum internal force N. Inner columns, internal axial force [kN]

References

[1] M.Just M.Curbach J.Walraven S.Gmainer J.Arrieta R.Frank C.Morin F.Robert SF.Biasioli, G.Mancini. Eurocode 2: background & applications. design of concrete buildings. worked examples. Technical report, European Comission, 2014.